

信興電工工程有限公司

SHUN HING ELECTRIC WORKS AND ENGINEERING CO., LTD.

辦公室：香港九龍尖沙咀東部麼地道67號半島中心9樓909-912室

電話：2861 2767

圖文傳真：2865 6706

網址：http://www.rasonic.com

電郵：shew@shunhinggroup.com

Office: Room 909-912 9/F., Peninsula Centre, 67 Mody Road, Tsimshatsui East, Kowloon, H.K.

Tel: 2861 2767

Fax: 2865 6706

Website: http://www.rasonic.com

E-mail: shew@shunhinggroup.com

保養及維修 Maintenance and Repair Service:

信興電器服務中心有限公司

SHUN HING ELECTRIC SERVICE CENTRE LTD.

香港新界葵涌勝耀街8號信興中心18樓

電話：2406 5666

圖文傳真：2408 0316

網址：http://www.shunhing-service.com

18/F, Shun Hing Centre, 8 Shing Yiu Street, Kwai Chung, N.T., H.K.

Tel: 2406 5666

Fax: 2408 0316

Website: http://www.shunhing-service.com

消耗品/附件銷售熱線：2406 5555

Consumable/Accessories Sales Hotline: 2406 5555

客戶服務中心：

香港新界葵涌勝耀街8號信興中心19樓

電話：(852) 2406 5439

傳真：(852) 2408 1389

澳門慕拉士大馬路193-199號南嶺工業大廈5樓1座

電話：(853) 2836 2928

傳真：(853) 2833 6405

有關最新客戶服務中心資訊，請參閱信興服務中心網址：www.shunhing-service.com或致電維修服務熱線查詢。

Customer Service Centres:

19/F, Shun Hing Centre, 8 Shing Yiu Street, Kwai Chung, N.T.

Tel: (852) 2406 5439

Fax: (852) 2408 1389

Avenida de Venceslau de Morais, No. 193-199, 5 andar-I, Edf.

Tel: (853) 2836 2928

Fax: (853) 2833 6405

Industrial Nam Leng, Macau

For the latest information of customer service centres, please visit www.shunhing-service.com or call us at our hotline.

 **Rasonic**
樂信牌

RTP-W25RT/ RTP-W30RT/ RTP-W40RT

電熱水瓶 Thermo Pot



僅供家庭使用
For household use only

使用說明書

OPERATION MANUAL

- 在使用本產品前，請仔細閱讀本說明書，閱讀後小心收藏，以備日後查閱。
- Please read the operation manual carefully before using. Keep it in a safe place for future reference.
- 本說明書中的圖示可能與實物不同的地方，僅供參考。
- The images in the operation manual may not match with the real object and are for reference only.

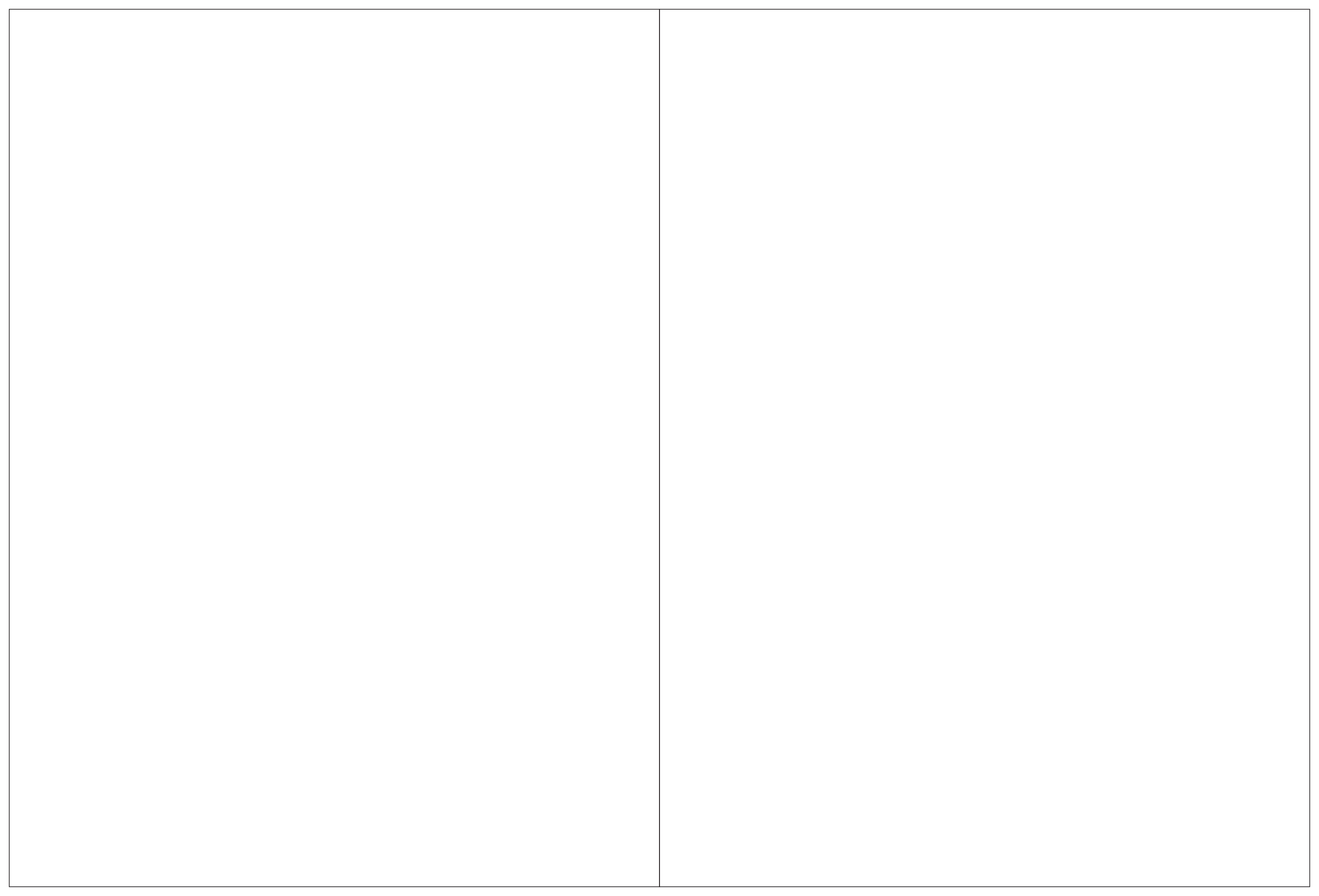

8. Special Avowal

1. The content in the operation manual has been checked. Our company reserves the hermeneutic power to any printing errors or misunderstanding on the content.
2. If there are technical improvements on the appliance, the operation manual will be updated in new version without prior notice. The product appearance and specification are subject to the manufacturer information.

9. After Sales Service

Shun Hing Electric Works & Engineering Co., Ltd. ("The Company") authorizes Shun Hing Electric Service Centre Ltd. ("SHESC") (collectively "Shun Hing") to offer one year warranty service to the product commencing from the date of purchase invoice. Services beyond the said warranty period will be charges according to the standard service charge price list from SHESC.

1. Shun Hing shall not be liable for any direct or indirect loss or damage to any person or property, howsoever caused arising from improper use, or any stoppage, breakdown or failure of the product.
2. Customer is responsible to deliver the product to our service station or any place in urban area, and to pick up the repaired product from the same location.
3. The warranty card (printed on the packing box) is valid only in Hong Kong and Macau. Customer is required to present this warranty card together with the official purchase invoice issued by the dealers of Hong Kong or Macau or redemption voucher to our technician for verification when service is rendered. The warranty card is valid only if the model number stated herein corresponds with that of the product and the date of purchase stated herein is the same with the date of official purchase invoice. Save and except the specified warranty card, any other warranty card issued by other parties will not be recognized by Shun Hing.
4. Customer shall not alter the serial number of the product. The warranty card is void if the serial number on the product does not match with that shown on the warranty card (if applicable).
5. For any defect which in our judgment is caused under normal use, SHESC will repair or replace the defective parts, excluding any surface, cabinet, consumptive parts and accessories, free of charge within the warranty period. Any defective part which has been replaced shall become the property of SHESC.
6. Warranty service does not cover the following items. Additional charges shall be levied if services are required. (a) Repair or replacement of accessories, external cables or cabinet of the product. (b) The product has been explicitly or implicitly modified, tempered with, altered or repaired in any way by persons other than technicians of SHESC. (c) The product has been damaged through misuse, negligence, power interruption or abnormal voltage input, accident, natural calamities, or due to ingress of insects, foreign matters or liquid, corrosion or external factors. (d) The normal operation of the product is affected by improper installation of the product.
7. In case there is any inconsistency or conflict between English version and Chinese version of the terms, the Chinese version shall prevail.
8. All terms stated are subject to change without notice. SHESC retains final deciding authority in case of dispute.
9. Nothing in the warranty card confers or purports to confer on any third party any benefit or any right pursuant to the Contracts (Rights of Third Parties) Ordinance (Cap. 623) to enforce any term of the warranty card.

非常感謝您選購樂信牌電熱水瓶，使用前請詳細閱讀本說明書，並保存以備日後參考。



目錄

1. 安全注意事項
2. 產品規格
3. 產品說明
4. 使用方法
5. 清潔及保養
6. 儲存
7. 故障排除
8. 特別聲明
9. 售後服務

1. 安全注意事項

使用本產品時，必須遵守下列安全措施：

下圖表示由於錯誤操作而引起不同程度的危險等級。

 警告： 此標誌表示可能造成傷亡。
 注意： 此標誌表示可能造成傷害或財物損失。

以下不同標誌區分各種必須遵守的指示。

 此標誌表示禁止。
 此標誌表示必須遵守。

 注意	
 使用前，請仔細閱讀相關的說明。如錯誤操作，可造成傷害。	 使用前，請確定產品表面清潔乾爽，否則可能引致故障。
 為免熱水溢出，當產品盛載著熱水時，切勿傾斜或搖晃產品，或用力關閉上蓋。移動產品時，請使用提手，切勿以上蓋作手挽。	 當溫度過高時，此產品會啟動防乾燒保護功能並自動截斷電源。
 使用時，確保產品與四周保持最少10厘米的距離作散熱空間。	 切勿從水龍頭或在洗滌槽中直接加水，否則可能導致水流入機內，造成電子零件故障或發生危險。
 切勿盛載水以外的液體 (如牛奶、茶或冰塊等)。	 倒去剩水時，應先卸上蓋 (請參考4.5上蓋裝卸方法)。使用時，請確保上蓋已關緊。
 切勿讓剩水長期留在內膽，否則可導致內膽變色或產生異味。	 使用後，必須從電源插座拔出插頭及待產品冷卻後才移動、清潔或檢查。
 不可放重物在電源線上；切勿夾住、改裝、用力拉扯或扭曲電源線。	 在插入或拔除插頭時，應用手握穩插頭本身，不要抓住電源線。
 切勿在電源線纏結的情況下使用此產品或將電源線懸掛在桌子、櫥櫃的邊緣或讓它接觸發熱的表面，否則可能造成電源線損壞。	 切勿在以下環境使用此產品： — 潮濕或近水的環境 — 被陽光直接照射或靠近熱源如焗爐、電磁爐及火源 — 不平穩的表面上 — 易燃物料或不耐熱物品附近 (如枱布、窗簾及毛巾等)

6. Maintenance of inner pot

When the thermo pot is in use, you may find some color spots attached on the inner pot surface, which may be in milky white, brown or black. This is the water scale formed by minerals in water. To prevent water scale or color spots, clean the inner pot regularly. Use a soft sponge to clean the inner pot. Do not use cleaning powder or metal brush to avoid damage to the inner pot surface.

To remove the water scale, please follow the below methods:

- Put 1-2 sliced lemon in the inner pot. (Or add about 20g citric acid for every 1 liter water.)
- Fill cool water into the inner pot till the full water level.
- Press the "Reboil" key to boil water. Pour all the water out after keeping warm for around 1 hour. Clean the inner pot with a sponge or soft brush, then rinse by water.
- In order to remove the remaining citric acid, you can refill water to boil again and pour out all water afterward.

6. Storage

1. Always let the thermo pot cool down. Then store it after clean and dry the inner pot completely.
2. Put the thermo pot in a box and store it in a dry place.
3. When store, never wrap the power cord tightly round the thermo pot or clip the power cord, it prevents power cord deterioration.

7. Troubleshooting

Trouble	Causes	Treatment
Water has white or shiny particles.	Water scale of inner pot peeled off.	Please follow the instructions of "Maintenance of inner pot" to remove the water scale.
Smell comes from the water.	<ul style="list-style-type: none"> • Tap water contains chlorine smell. • The smell comes from the sealed packing at the beginning. 	<ul style="list-style-type: none"> • Press "Reboil" key to eliminate the chlorine smell. • The smell will disappear with time. Boiling water with lemon or citric acid can eliminate the smell.
Water dispense is not smooth.	The water filter is blocked.	Clean the filter with a soft brush.
Water dispenses automatically.	Water is filled above the full water level.	Pour water out until water is below the full water level.
The thermo pot cannot boil water.	The plug is not connected securely.	Check and re-connect the plug.

If the above solutions cannot fix the problem, please contact Shun Hing Electric Service Centre Ltd. to check and repair.

4.4. Dispense water

- Electric pump: Press the "Lock / Release" key, the lock / release indicator will be on. Put a cup under dispensing spout and press the "Pour" key to dispense water. The dispense function will be locked automatically after the "Pour" key is released for 10 seconds.
- Cup Push: Press the "Lock / Release" key, the lock / release indicator will be on. Put a cup under dispensing spout and push the "Cup Push" button by the cup to dispense water. The thermo pot will be locked automatically after the "cup push" button is released for 10 seconds.
- ※ It is normal if there are few water drops after releasing the "Pour" key or "Cup Push" button. Make sure the water has stopped dispensing before removing the cup from the dispensing spout.
- ※ If the unit is unplugged, water cannot be dispensed.

4.5. Sleep mode setting

- This appliance is with the built-in energy saving sleep mode setting. If there is no operation or boiling water by reconnecting the power, the thermo pot will automatically enter the energy saving sleep mode. The keep-warm function will turn off and all the indicator will be off. Press any key to restart the thermo pot and it will enter the boiling process. After boiling, the thermo pot will switch to keep-warm mode.

4.6. Install and detach lid method

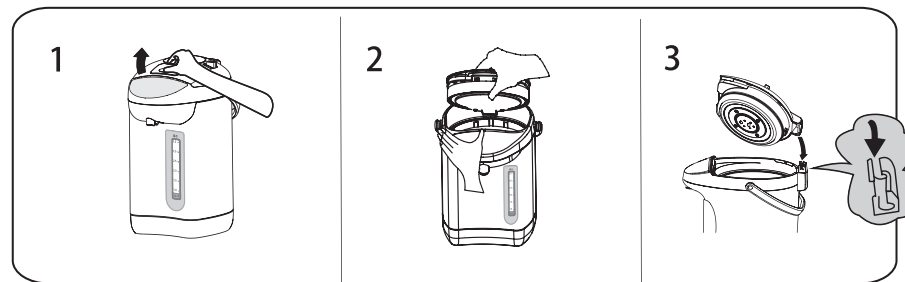

1. Open the lid – Press and pull up the lid release lever to open the lid.
2. Draw the lid out – Lift the lid at angle 45 degree and pull it out.
3. Install the lid – Fix the metal axis at the end of the lid into the back of the thermo pot shown in picture 3.

5. Cleaning and Maintenance

1. Unplug the thermo pot and allow it to cool down completely before cleaning.
2. It is recommended to empty the remnant water in the thermo pot everyday, otherwise water scale may form on the inner pot or cause bad smell. Before pouring out water, ensure to unplug the thermo pot and detach the lid. When pouring out the remnant water, be sure that water does not splash onto the control panel, or get into the appliances, grip the handle and hold the main body firmly, then tilt the main body slowly to pour.
3. Do not wash the thermo pot with water directly. Wipe the main body surface by a damp cloth.
4. Do not use any poisonous or corrosive detergent to clean the thermo pot. If it is too dirty, wipe the main body with a damp cloth soaked with mild detergent, then wipe with a clean damp cloth.
5. Maintenance of the lid

The lid will deteriorate after long time usage, the degree of deterioration varies with the water quality and usage frequency. If the lid is damaged or cracked which hinder the water dispense, please contact Shun Hing Electric Service Centre Ltd. for checking or purchase a new lid for replacement.

警告			
	使用前，確保電源線兩端的插頭分別插緊在產品及電源插座上，否則可能因接觸不良導致電源線過熱。		切勿與其他高功率的電器同時共用同一電源插座；或超額使用電線拖板，以防電力負荷過重而導致火災。
	使用前，確保插頭已充分擦乾。		切勿讓此產品在無人看管下運作。
	切勿用任何物件覆蓋產品表面或遮擋蒸氣口，以免造成變色或變形。		需時常留意水位，必須在水位低於注水指示線前注水，避免引起產品乾燒。
	切勿注水超過滿水指示線，否則使用時熱水可能噴出，造成燙傷。		切勿把此產品、電源線或插頭浸入水中；或被水濺濕，以免造成觸電或火災。
	切勿讓小孩單獨使用、清潔及維修保養此產品或將其當作玩具。請將此產品及其電源線放於小孩不能觸及的地方。		切勿擅自改裝此產品或使用非生產商提供的零件進行修理，否則可造成危險及維修保養將會無效。
	出水時，切勿旋轉產品，以免熱水飛濺及造成燙傷。		手濕時切勿接觸、插入或拔除插頭，否則可能構成觸電。
	當水沸騰時，切勿使用出水功能或打開上蓋，否則會導致熱水飛濺或大量蒸氣噴出，可能造成燙傷。		經常檢查此產品、電源線及插頭，如有損壞，為避免危險，請立即停止使用，並聯絡信興電器服務中心有限公司安排檢查及維修。
	當產品內沒有水時，切勿啟動產品，避免引起乾燒。如果產品經常出現乾燒，可能會令內膽變黃，並影響產品的功能及耐用性。		此產品只供家庭或類似環境使用，如商店內部、辦事處和其他工作環境的員工廚房區域；旅館、汽車旅館和其他住宿類型的環境。
	此產品可供年齡在8歲或以上的兒童及體質、感覺或智力有障礙人士或缺乏經驗和相關知識的人士使用，但他們必須接受負責安全人士的監督或指導如何安全地使用此產品和理解所涉及的危險。		使用時或剛使用後，會有大量灼熱蒸氣由蒸氣口噴出。為避免燙傷，切勿將臉頰或手等靠近或接觸上蓋或蒸氣口；或觸碰變熱的表面如外殼。切勿觸摸使用後的發熱部份，因仍有餘熱。

2. 產品規格

型號	RTP-W25RT	RTP-W30RT	RTP-W40RT
額定電壓	220-240伏特 ~ 50/60赫茲		
額定功率	750-890瓦		
內膽物料	不鏽鋼		
容量(升)	2.5	3.0	4.0
淨重(公斤)	1.8	1.9	2.1
產品尺寸(闊 x 深 x 高)(毫米)	219 x 284 x 258	219 x 284 x 286	219 x 284 x 332

※ RTP-W25RT的機身是金屬物料，所以機身溫度會比較高。

3. 產品說明

控制面板說明

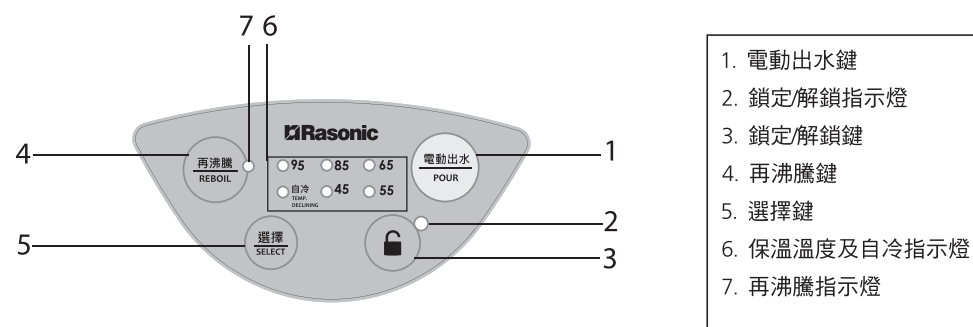

產品結構

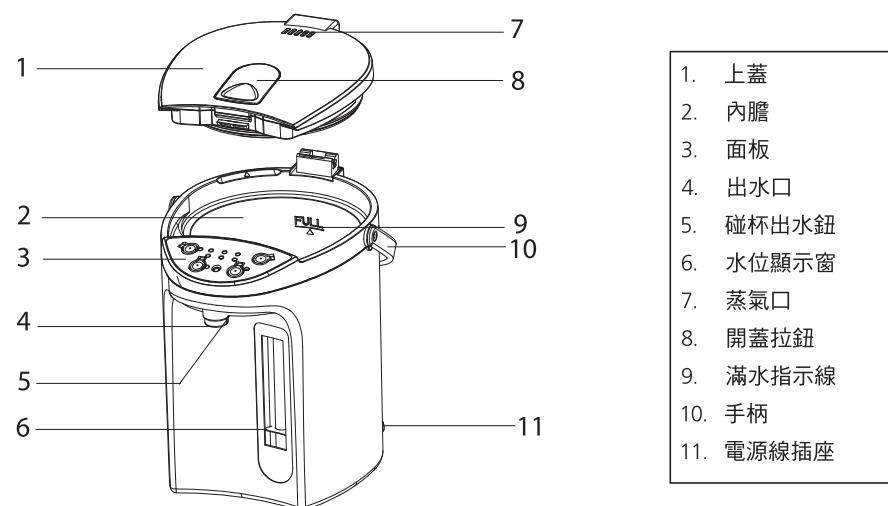

4. Operation Instructions

4.1. First use

- When the unit is new, it may have smell due to the new packing. The smell will gradually disappear with time.
- Before first use, it is recommended to clean the inner pot by boiling water. After boiled, press "Pour" key to dispense half of the hot water to clean the water dispense system and then empty the inner pot.
- ※ For first use, please do not use lemon or citric acid to clean the inner pot otherwise it may cause color change on the inner pot of the thermo pot.

4.2. Fill water

- Open the lid and fill cool water into the thermo pot.
- Beware the water level must not exceed the full water level.
- After filled water, close the lid securely until a snap sound is heard.

4.3. Boil/Reboil → Keep warm or Temperature declining (Cooling)

- Plug in both ends of the power cord tightly into the appliance and the power socket. The thermo pot will automatically enter the boiling process. The reboil indicator will be on, 85°C indicator will flash.
- When the water is boiling, press "Select" key to set the keep warm temperature, the corresponding keep warm indicator will flash and the setting sequence will be: 85°C→65°C→55°C→45°C→Temp. declining→95°C. The thermo pot will keep warm at 85°C automatically if keep warm temperature is not set.
- After boiled, the reboil indicator will be off, the thermo pot will switch to keep-warm mode automatically, the corresponding keep warm indicator will be flash until the water reach the keep warm temperature. When the water temperature cool down to the keep warm temperature, the corresponding keep warm indicator will be on.
- ※ If you selected Temp. declining(cooling) function, the temp. declining indicator will flash until the water reach 40°C or below, the temp. declining indicator will be on.
- If you need to reboil the water, please make sure water must be above the refill level before reboiling, otherwise water should be refilled. Press the "Reboil" key, the reboil indicator will be on and the corresponding keep warm indicator will flash.
- After reboiled, the reboil indicator will be off, the thermo pot will switch to keep-warm mode automatically. The corresponding keep warm indicator will be flash until the water reach the keep warm temperature. When the water temperature cool down to the keep warm temperature, the corresponding keep warm indicator will be on.
- ※ Temp. declining (cooling) status means the keep warm function is deactivated, water will gradually cool down to room temperature. When using cooling function, must connect the thermo pot to the power sources, so the electric pump and cup push function can be used.
- ※ This is normal that some bubbling sounds can be heard from inside the container when the water is being boiled.
- ※ When boiling water, the air pressure increases will cause the water dispenser may not produce a smooth water flow. Release the air pressure by opening the lid and close the lid, then dispense water. Caution for hot steam.

2. Product Specification

Model	RTP-W25RT	RTP-W30RT	RTP-W40RT
Rated voltage	220-240V~ 50/60Hz		
Rated power	750-890W		
Inner Pot Material	Stainless Steel		
Capacity (L)	2.5	3.0	4.0
Net Weight (kg)	1.8	1.9	2.1
Product Size (W x D x H) (mm)	219 x 284 x 258	219 x 284 x 286	219 x 284 x 332

※ The body of RTP-W25RT thermo pot is made of metal, so the temperature may be relatively high.

3. Product Description

Control Panel Description

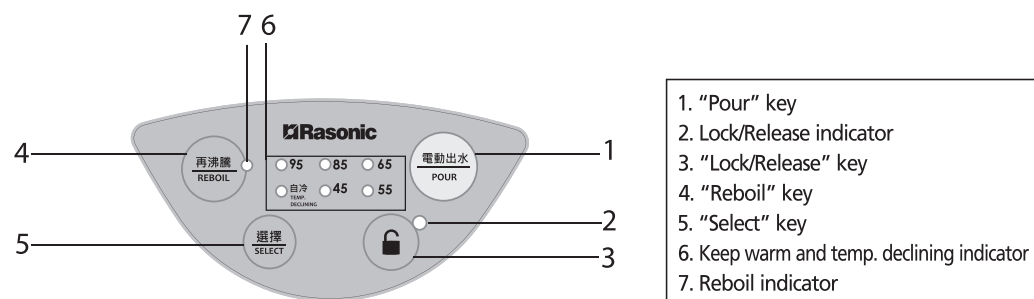

Product Structure

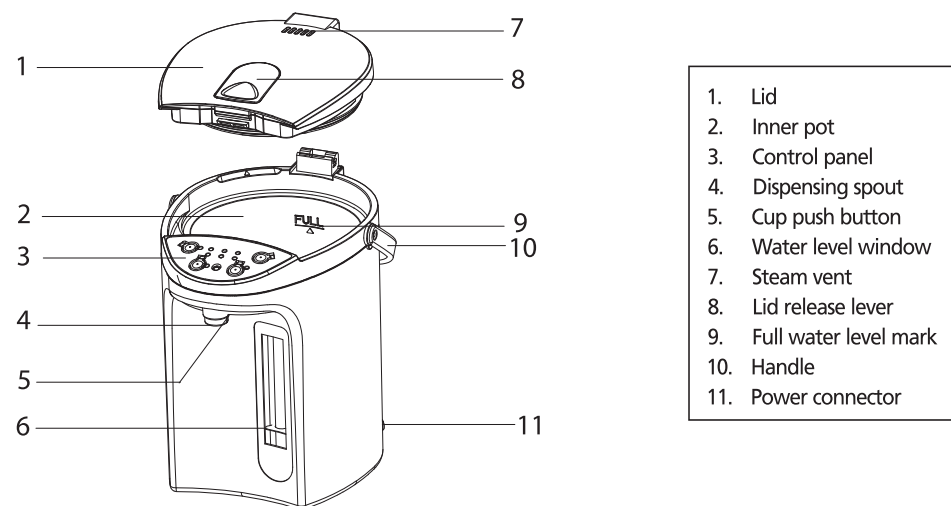

4. 使用方法

4.1. 首次使用

- 首次使用時，可能會有新包裝物料的異味，經使用後會逐漸消失。
- 首次使用時，建議先加入水沸騰作清洗內膽。沸騰後，按“電動出水”鍵排出一半熱水清潔出水部份。之後，將剩下的熱水倒掉。

※ 注意：首次使用時不可使用檸檬或檸檬酸清洗內膽，否則可能會造成內膽變色。

4.2 加水

- 打開上蓋，把冷水注入電熱水瓶內。
- 請注意水量不可超過滿水指示線。
- 注水後，將上蓋關緊直至聽到「喀嚓」的扣合聲。

4.3. 沸騰 / 再沸騰→保溫或自冷

- 將電源線插緊在電熱水瓶和電源插座上。電熱水瓶會自動進入加熱狀態，再沸騰指示燈會亮起，85°C指示燈會閃動。
- 當水加熱時，可按“選擇”鍵設定保溫溫度，相應保溫溫度指示燈會閃動，溫度設定的循環次序為：85°C→65°C→55°C→45°C→自冷→95°C。如沒有設定保溫溫度，水沸騰後會自動保溫在約85°C。
- 當水沸騰後，再沸騰指示燈會熄滅，電熱水瓶會自動轉為保溫狀態，相應保溫指示燈會閃動直至到達指定溫度。當水溫降至保溫溫度時，相應保溫溫度指示燈會轉為長亮。

※ 如選擇自冷功能，自冷指示燈會一直閃動，直到水溫下降至40°C或以下。自冷指示燈會轉為長亮。

- 若需再次沸騰瓶內的水時，須確定水量超過注水指示線，否則應該再次注水。按下“再沸騰”鍵，再沸騰指示燈會亮起及相應保溫溫度指示燈會閃動。

- 再沸騰後，再沸騰指示燈會熄滅。電熱水瓶會自動轉為保溫狀態，相應保溫溫度指示燈會閃動，直到水溫降至保溫溫度時，相應保溫溫度指示燈會轉為長亮。

※ 自冷狀態是指電熱水瓶保溫功能暫停，瓶內的水溫漸漸下降至室溫。使用自冷功能時，必須保持通電狀態，才可使用電動及碰杯出水。

※ 在煲水時會發出「咕嘟」的聲音是水泡迸裂之聲響，屬正常現象。

※ 沸騰所產生的氣泡可能會造成熱水排出困難。為了排出氣壓，可打開上蓋再關上，之後按出水鍵。期間小心蒸氣。

4.4 出水方式

- 電動出水：先按“鎖定/解鎖”鍵，鎖定/解鎖指示燈會亮起，把杯放在出水口下方並按“電動出水”鍵出水。停止按“電動出水”鍵約10秒後，電熱水瓶會自動轉為出水鎖定狀態。
- 碰杯出水：先按“鎖定/解鎖”鍵，鎖定/解鎖指示燈會亮起，把杯觸碰出水口後方的“碰杯出水”鈕出水，停止觸碰“碰杯出水”鈕約10秒後，電熱水瓶會自動轉為出水鎖定狀態。

※ 在停止觸碰“電動出水”鍵或是“碰杯出水”鍵之後，出水口可能有少量的水滴出，屬正常現象，確定沒有出水後，方可將杯拿開。

※ 拔除插頭後，即無法出水。

4.5. 休眠省電裝置

此電熱水瓶內置48小時休眠省電裝置。如在48小時內沒有按任何鍵或重新插上電源加熱電熱水瓶內的水，電熱水瓶會自動啟動休眠省電裝置，停止保溫功能及所有指示燈熄滅。按任何鍵，即可重新啟動電熱水瓶，並會加熱電熱水瓶內的水。當水沸騰後，電熱水瓶會轉為保溫狀態。

4.6. 上蓋裝卸方法

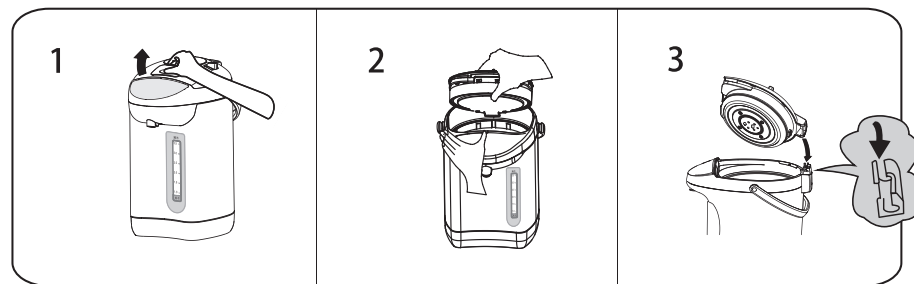

1. 開啟上蓋 — 按下開蓋鈕，再向上拉開上蓋。
2. 拆除上蓋 — 打開上蓋至45度角，向前拉出上蓋。
3. 安裝上蓋 — 將上蓋軸以45度角插入圖3的機背位置。

5. 清潔及保養

1. 清潔前，必須先拔掉電源插頭，並待電熱水瓶冷卻後才能進行。
2. 建議每天要把剩餘熱水倒掉，否則內膽會形成水垢或產生異味。倒水前，必須拔掉電源插頭及卸下上蓋。倒水時，切勿讓水濺到面板或進入機內，用手按緊把手及拿穩機身，才慢慢傾斜機身將剩水倒掉。
3. 切勿用水直接沖洗電熱水瓶，應用濕布擦拭機身表面。
4. 切勿使用有毒或含腐蝕性的清潔劑進行清潔。若污漬太多，可用軟布沾上稀釋的中性清潔劑擦拭機身，然後用乾淨的濕布抹淨。
5. 上蓋的保養



上蓋會因長期使用而損耗，損耗的程度會因水質和使用次數而不同。如發現上蓋損壞或有裂痕時而導致出水困難，請聯絡信興電器服務中心有限公司進行檢查或購買新上蓋更換。

Warning			
	Make sure both ends of the power cord are plugged in tightly on the appliance and the power socket before use. Otherwise, it will cause power cord overheat due to contact failure.		Do not share the same socket with other high power appliances or use the extension cord beyond its capacity; otherwise it will cause power overload and fire.
	Make sure the plug is dry before use.		Never leave the appliance unattended when in use.
	Never cover the appliance surface or block the steam vent with any objects, otherwise it may discolor or deform.		Always pay attention to the water level. Make sure to refill water before the water level is below the refill level to avoid boil-dry.
	Do not add water exceed the full water line. Otherwise hot water may spill out during operation and cause burns.		Never immerse the appliance, power cord or plug in water or let them wet, it can cause electric shock or fire.
	Never allow children to operate, clean, perform maintenance on the appliance alone or play as toy. Please put the appliance and its power cord in a place not reachable by children.		Do not attempt to modify the appliance by yourself or repair with any unauthorized parts, otherwise it will cause hazards and warranty will become invalid.
	Do not rotate the appliance while dispensing water, otherwise the hot water may spill out and cause burns.		Do not touch, plug in or remove the plug with wet hands, it can cause electric shock.
	Do not use the dispense function or open the lid while boiling, the hot water may spill out or mass steam will come out which can cause burns.		Always check the condition of the appliance, power cord and plug. To avoid hazards, stop using the appliance immediately and contact Shun Hing Electric Service Centre Limited for checking and repairing if any of the parts is damaged.
	Do not operate the appliance when it is empty, it is to avoid boil-dry. The inner pot will become yellow, the performance and durability of the appliance will be affected if it is boiled dry frequently.		The appliance is intended to be used in household or similar applications such as staff kitchen area in shops, offices and other working environments; by clients in hotels, motels and other residential type environments.
	The appliance can be used by children aged from 8 years and above and persons with reduced physical, sensory or mental capabilities, or lack of experience and knowledge if they have been given supervision or instruction concerning use of the appliance in a safe way and understand the hazards involved.		Mass hot steam comes out from the steam vent during use or right after used. To avoid burns, do not get your face or hands close or touch the lid or steam vent, or touch the hot surfaces e.g. housing. Never touch the heating parts after use which are subject to residual heat.



1. Important Safeguards















When using the appliance, please follow the below safety precautions:

The following chart indicates the degree of damage caused by wrong operation.

	Warning: Indicates that may cause death or serious injury.
	Caution: Indicates hazards that may cause human injuries or property damages.

The following symbols can distinguish the instruction types that need to be strictly followed.

	These symbols mean prohibition.
	These symbols mean requirement that must be followed.

 Caution			
	Read all instructions carefully before use. Misuse can cause potential injury.		Make sure the appliance surface is clean and dry before use, otherwise it may cause malfunction.
	To avoid hot water from spilling out, do not tilt or shake the appliance or close the lid by force when it contains hot water. When move the appliance, catch its handle instead of the bare lid.		The appliance will trigger the boil-dry protection and cut off the power automatically when the temperature is too high.
	During operation, keep at least 10cm space at all sides of the appliance for air circulation.		Do not fill water directly from the tap or in a sink, otherwise water may get into the appliance, it may cause electronic parts malfunction or danger.
	Do not contain other liquids except water (e.g. milk, tea, ice, etc.)		Detach the lid (refer to 4.5 Install and detach lid method) before pouring out the remnant water. Make sure the lid is closed tight when in use.
	Do not leave the remnant water in the inner pot for a long time, it may cause color change on the inner pot or produce bad smell.		After use, please unplug the appliance and let the appliance cool down before moving, cleaning or checking.
	Do not place heavy objects on the power cord. Never clip, modify, stretch or twist the power cord.		Grasp the plug itself when plug in or unplug the appliance, do not grasp the power cord.
	Do not operate the appliance when the power cord is tangle or hang the power cord over the edge of table, counter-top or let it touch any hot surface, it may cause power cord damage.		Do not operate the appliance in the following places: <ul style="list-style-type: none"> - Humid environment or near water - Expose to sunlight or near heat sources such as electric oven, induction cooker and fire - Unstable surface - Near inflammable or non-resistant to heat objects (e.g. table cloth, curtain and towel etc.)

6. 內膽的保養

在使用時，用戶可能發現內膽表面出現色點如乳白色、啡色或黑色，這是由於水中含有礦物質所引起，請定期清洗，以防止形成水垢或色點。可用海綿清洗內膽，切勿使用去污粉或金屬刷擦拭內膽，以免內膽表層受損。

如要清除水垢，可使用以下清洗方法：

- 將1-2個已切片的檸檬放入瓶內，(或以每升水加入20克檸檬酸。)
- 於內膽注入冷水至滿水指示線。
- 按“再沸騰”鍵將水加熱。保溫約1小時後，把瓶內的水全部倒掉，並用海綿或軟毛刷清洗內膽，然後用水沖洗。
- 為去除剩餘的檸檬酸，可再次注水沸騰，然後把開水倒掉即可。

6. 儲存

1. 必須待電熱水瓶完全冷卻及將內膽完全清洗及乾透後，才可儲存。
2. 將電熱水瓶放入紙箱，然後儲存在乾爽的環境中。
3. 儲存時，切勿將電源線纏繞在電熱水瓶四周或壓住電源線，避免造成電源線磨損。

7. 故障排除

問題	原因	處理方法
水中有白色或閃光的物質。	這是脫落的水垢。	請按「內膽的保養」的方法去除水垢。
水有異味。	<ul style="list-style-type: none"> • 自來水中含有消毒用氯氣，導致產生異味。 • 電熱水瓶的封閉包裝會令使用初期有少許異味。 	<ul style="list-style-type: none"> • 可按下“再沸騰”鍵清除氯味。 • 隨著使用次數增加將會消失；或用檸檬片或檸檬酸放進水裏加熱，即可減退異味。
出水不暢。	出水過濾網被堵塞。	請用軟毛刷清洗過濾網。
水自動流出。	注水超過滿水指示線。	減少內膽內的水量至低於滿水指示線。
不能煲水。	插頭未有徹底連接。	檢查及重新連接插頭。

如使用以上方法後仍未能解決問題，請聯絡信興電器服務中心有限公司進行檢查及維修。

8. 特別聲明

1. 此說明書所有內容經過核對，如有任何印刷錯誤或內容上的誤解，本公司將保留解釋權。
2. 本產品若有技術改進，會編進新版說明書中，恕不另行通知；產品外觀及規格以廠方資料為準。

9. 售後服務

信興電工工程有限公司(「本公司」)將授權信興電器服務中心有限公司(「服務中心」)(統稱「信興」)提供一年保修服務並由發票上的日期起計。超過這期間者，客戶須按服務中心的修理服務價目表繳付一切費用。

- (1) 信興對於任何因產品不適當地使用或任何產品之故障、損壞或停頓而引致任何人士或財產的直接或間接損失及破壞，概不負責。
- (2) 客戶須自行將產品送往客戶服務中心或市區內，並於產品修妥後於同一地點取回。
- (3) 保修卡(印在包裝盒上)只適用於香港及澳門。於修理時，客戶需出示保修卡及由香港或澳門經銷商發出的正式發票 / 或換購收據予技術員查閱。保修卡上之產品型號必須與機身相符，保修卡上之購買日期須與正式發票上的日期符合，方為有效。除指定保修卡外，任何商號及人士發出之保修卡，均不為信興認可。
- (4) 客戶不可擅自更改產品上的機身編號，如發現產品上的機身編號與保修卡所列者不符，保修卡則告無效。(如適用)
- (5) 除產品表面、機殼、損耗性零件及附件外，產品如發生故障，經服務中心證實乃在正常使用情況下發生者，服務中心將提供免費修理及更換零件，經更換後之任何損壞零件，將歸服務中心所有。
- (6) 下列項目並不包括於保修範圍內。客戶須另付所需的服務費用。(甲)修理或更換產品之附件、外接線及機殼。(乙)曾被非服務中心的技術員明顯地或不明顯地進行改裝、更改或修理的產品。(丙)曾經被不適當或疏忽使用、不正常供電或電壓不正常、意外、天災或因昆蟲、外物、液體入侵、腐蝕或外來因素而造成損壞的產品。(丁)因產品不正確安裝而影響正常之操作。
- (7) 如中英文版本有差異時，應以中文版為準。
- (8) 所有資料如有任何更改，恕不另行通知。如有任何爭議，服務中心保留最終決定權。
- (9) 本保修卡沒有賦予或意圖賦予任何第三者因《合約(第三者權利)條例》(第623章)所列之任何利益或權利以強制執行本保修卡的任何條款內容。

Thank you for choosing Rasonic Thermo Pot. Please read the operation manual carefully before use and keep it for your future reference.

Table of Contents

1. Important Safeguards
2. Product Specification
3. Product Description
4. Operation Instructions
5. Cleaning and Maintenance
6. Storage
7. Troubleshooting
8. Special Avowal
9. After Sales Service