

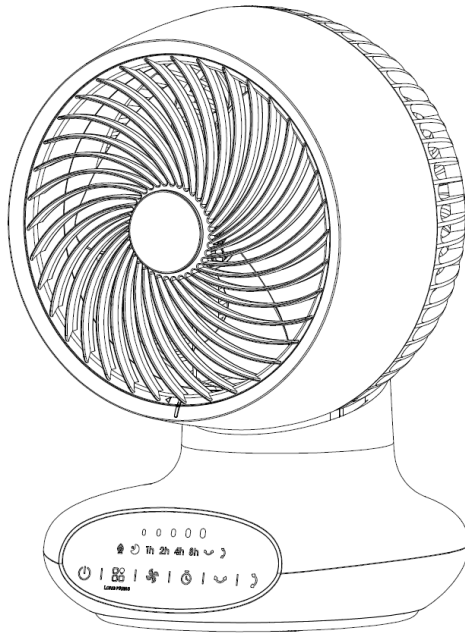

CIRCULATION FAN 循環扇

OPERATION MANUAL 使用說明書

RCF-6WL



僅適用於家庭使用 For Household Use Only

使用前請先詳細閱讀本說明書，並保存以便日後參考。

本說明書中所有圖片僅供解釋用途。

Please read this user manual before using the product and retain it for your future reference.

All the pictures in this manual are for reference only.

安全注意事項 (請務必詳細閱讀及遵守安全指導)

- 請務必嚴格遵守以下說明之注意事項以防止對使用者或其他人造成傷害或財物損失。
- 用戶必須使用有安全認證的合格插座，否則，可能會引起火災的危險。
- 此設備可供 8 歲以上兒童，肢體、感官、心智殘缺或缺乏經驗和知識的人使用，但他們必須已獲得監督和安全使用該設備的指導，並且了解其中的危害。兒童不應將本產品用於玩耍。清潔和保養，不得讓兒童在沒有監督的情況下實施。本設備是不打算供與(包括兒童)身體，感官或智力有障礙，或缺乏經驗和知識人士使用，除非他們是在負責他們安全的人員監督或有關使用該設備的指示下使用。兒童應當受到監督以確保他們不會玩耍器具，請勿讓兒童爬上風扇。
- 拔掉電源線插頭時須緊握，切勿拉扯電線。
- 確保電源插頭完全插入插座，否則會引致觸電或插頭過熱而造成火災。
- 要定期清除電源插頭及插座上之灰塵，否則引致絕緣不良而導致火災。
- 若電源線有裸露或有損壞時，切勿使用本機。避免危險，必須交由信興電器服務中心有限公司維修。如果電源線損壞或產品出現故障，必須交由信興電器服務中心有限公司維修，以避免危險。請勿私自拆卸、檢修，或更換非生產商提供的配件。
- 切勿過度擰捏，彎曲或扭轉電源線，否則線芯可能會曝露在外或折斷。
- 嚴禁讓機體沾水，否則會導致漏電、短路、產品損壞及導致火災的可能。
- 為避免過熱，禁止覆蓋機體。
- 切勿將物品放置在機體上。
- 手濕時切勿接觸電源插頭，否則有觸電的危險。
- 請勿讓手指或其他異物插入機體任何通風或排氣口，這可能會導致觸電、身體損傷、火災或損壞機體。
- 本機在使用時不可用力敲擊或震動機身。
- 請勿在陽光直射下使用產品。
- 電源線要擺放好，防止行走時拌倒。
- 機器要放在平坦堅實的地面上工作。
- 嚴禁在以下場所使用風扇：接近氣體爐具/有易燃氣體的地方/有雨淋或容易被滴水的地方/接近殺蟲劑的地方/油性的腐蝕性溶劑附近/高溫的地方/潮濕的地方/

在化學物品、油、多塵的地方

- 機體上方不可掛滴水的衣物或受到雨淋，避免進水發生漏電危險。嚴禁將可燃物及未乾的衣物覆蓋在機器出風口上，避免發生火災或觸電危險。
- 請勿在產品周圍噴灑殺蟲劑及可燃性噴霧劑，否則可能使產品受損。
- 為了安全起見，當人離開產品時，必須關機，以免發生意外事件。
- 避免將產品出風口長時間、直接向幼兒吹風。
- 產品清洗，檢修或移除面蓋前必須先切斷電源並拔掉電源線插頭。
- 產品外殼清潔時，應用濕布(或加點洗潔精)抹擦，不要有腐蝕性的洗滌劑或溶劑之類清潔，嚴禁用水沖(淋)洗。
- 不可將本機進、出風口貼近牆壁、窗簾等物品，否則會阻塞氣流，影響使用效果。
- 本機在使用一段時間後，若出現異聲或風速不均勻的現象，可能是後殼進風口處的灰塵太多阻塞了氣流，此時用毛刷清潔一下後即可恢復正常。
- 產品長期不使用時，應拔下電源插頭，包好本機防止灰塵進入機內，並放置乾燥通風處存放。

部件名稱

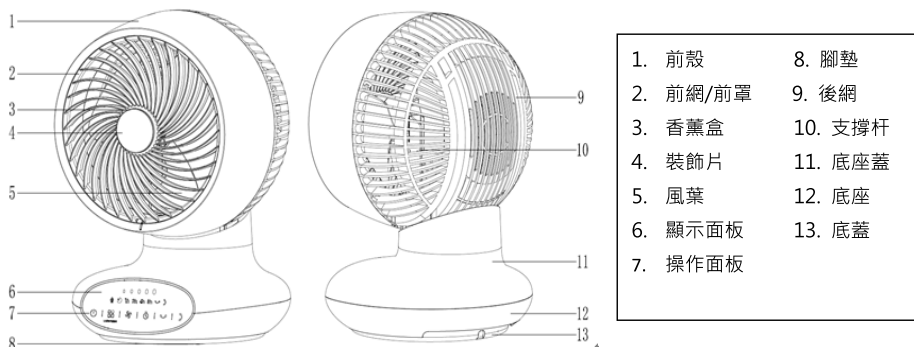

操作面板和顯示面板

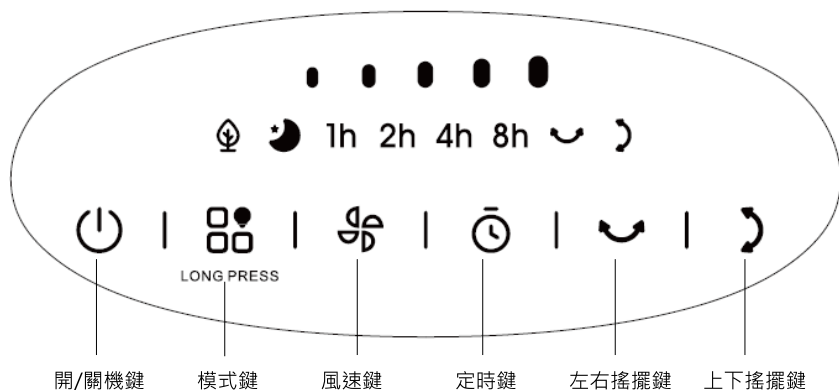

遙控器

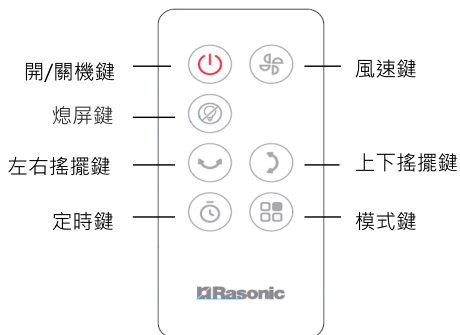

電池更換

將電池插入搖控器

- ① 搖控器背面有一個電池盒。請在壓下電池盒側面的同時將其拉出。
- ② 正面朝上放入硬幣形鋰電池(CR2032)。
- ③ 放入電池後，滑動電池盒，然後插入並固定電池盒。

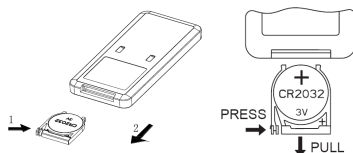

清潔保養







- 清潔、保養或移動產品前，必須先關閉產品，然後拔除電源插頭。
- 必須待風扇完全停止轉動後才可清潔及檢查，以免受傷。
- 切勿將電源線、插頭或主機浸在水中清潔或在水龍頭下沖洗，風扇內部零件不可沾水。
- 切勿使用鋼絲刷、汽油、火酒、醋或其他揮發、有毒或含腐蝕性液體清潔產品，以免損壞產品。
- 用微濕的布清潔風扇表面即可。
- 清潔完畢，必須待產品完全乾燥，才可連接電源使用。
- 儲存時，切勿將電源線纏繞在產品四周或壓住電源線，以免造成電源線損壞。
- 建議最少每個月清潔產品一次。
- 如長時間不使用產品，請將產品收藏回包裝盒內並放置在乾燥陰涼且安全的地方。

拆卸扇葉

- 請先除下前殼下方的1顆螺絲，逆時針旋轉前網，拆除扇葉圓蓋，然後拆下扇葉清洗。
- 安裝時，請確保扇葉已完全嵌入，否則扇葉可能無法轉動及正常運作。

使用說明

初次連接電源，蜂鳴器發出「嗶嗶」兩聲，進入待機狀態，所有功能指示燈均關閉，除電源鍵外，按其他鍵均無效。

	開/關機鍵 按此鍵開機，開機後，初始默認為正常模式 2 檔風速運行，● ●燈亮，不擺頭，無定時。
	模式鍵 選擇正常、自然(☀️)、睡眠(🌙)三種模式。啟動本產品時將預設為正常模式，此模式無指示燈顯示。
	風速鍵 本機備有 5 段風速，每亮起一顆 LED 燈代表一段風速，可按風速鍵來調節風速。
	定時鍵 選擇所需的定時關機時間 (1 / 2 / 4 / 8 小時)。
	左右遙擺鍵 按此鍵可開啟或關閉左右搖擺功能。
	上下搖擺鍵 按此鍵可開啟或關閉上下搖擺功能。

額外功能

1. 指示燈亮度變暗/ 熄滅功能

自動亮度變暗 - 以最後一次操作 60 秒後，所有指示燈將自動亮度變暗。

指示燈熄滅 - 在控制面板長按“模式”鍵 3 秒或在搖控器上按  鍵，所有指示燈將熄滅。

2. 不斷電記憶功能

非首次開機，在待機狀態下按電源鍵，啟動後保持關機前狀態，定時和睡眠風設定除外。

香薰盒的使用

1. 將香薰蓋按圖中箭頭 1 方向，逆時針旋轉解鎖扣位後，順著箭頭方向 2 取出來。
2. 把羊毛氈裝到香薰蓋裏面，並滴入幾滴精油（請勿大量滴入，防止溢出損傷產品）。
3. 將香薰蓋順時針卡入原位即可。

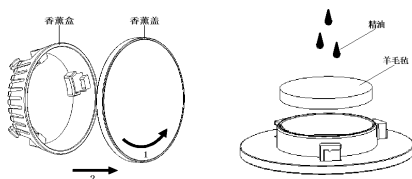

規格

產品型號	RCF-6WL
顏色	白色
額定電壓	220-240V 伏特 ~
額定頻率	50 赫茲
額定功率	35 瓦
外型尺寸 (寬×深×高)	186 x 200 x 290 毫米
淨重	2 公斤

特別聲明

1. 本資料上所有內容經過認真核對，如有任何印刷及內容上的誤解，本公司將保留解釋權。
2. 本產品若有技術改進，會編進新版說明書中，恕不另行通知；產品外觀及顏色如有改動，則以實物為準。
3. 用戶如需要電子版使用說明書，請致電信興電工工程有限公司熱線查詢：2861 2767。

售後服務

由購買日期起之一年保修期內，經信興電器服務中心有限公司之服務人員證實乃在正常使用之情況下發生者，本公司將提供免費修理及更換零件。經更換之任何損壞零件，將歸屬本公司。保修範圍不包括修理或更換產品之附件、外接線及機殼等，如有需要服務時，用戶須另付費用。

用戶請於維修時出示購買收據 / 換購收據及保修證，如有任何疑問，請致電信興電器服務中心有限公司熱線查詢：2406 5666。

如在保修證內所列之電器：1.) 曾經被非本公司技術人員明顯地或非明顯地進行改裝、更改或修理；或 2) 曾經被錯誤或不適當或疏忽使用、或因液體浸蝕、水濺、不正常供電、天災、意外或外來因素造成損壞；或 3) 並非安裝在陸上固定地點；或 4) 不當安裝位置影響正常操作；或 5) 非工商業用型號產品，被用作工商業用途；或 6) 用戶搬遷地址或更換物主而未能及時通知信興電器服務中心有限公司者，保修證將自動失效。

SAFETY PRECAUTIONS (Be sure to read carefully and follow these safety directions)

- Be sure to observe the following safety precautions in order to avoid possible injury to yourself or others and damage to your belongings.
- The user must use qualified socket with safety certification, or it may cause fire.
- This appliance can be used by children aged from 8 years and above and persons with reduced physical, sensory or mental capabilities or lack of experience and knowledge if they have been given supervision or instruction concerning use of the appliance in a safe way and understand the hazards involved.
- Children shall not play with the appliance. Cleaning and user maintenance shall not be made by children without supervision. Do not allow children to climb on the fan.
- Hold the main plug when disconnect from the power supply, never pull the supply cord.
- Make sure main plug is fully inserted into socket. Loose engagement of main plug and socket may cause electric shock or fire due to overheating of the main plug.
- Wipe off dust on the main plug and socket periodically. Accumulation of dust on main plug may cause poor insulation and may result in fire.
- Do not use the fan when the power cord or main plug is damaged. If the supply cord is damaged, it must be replaced

by the Shun Hing Electric Service Centre Limited in order to avoid the hazard. If the power cord was damaged or the fan was malfunction, please take the fan to Shun Hing Electric Service Centre Limited for repairing, please do not dismount, repair or replace with parts and accessories without authorities.

- Do not pinch, bend, or twist the power cord excessively. The core conductors may be exposed or broken which may cause electric shock, short circuit, fire and product damage.
- Do not contact with water. It may cause fire and electric shock.
- Do not cover the fan in order to avoid overheating.
- Please do not put any object on the fan body.
- Never touch the fan with wet hands to avoid electric shock.
- Do not insert fingers or conductive object into the front and back air outlets of the machine to avoid the risk of human injury or electric shock.
- Avoid any shocks, frictions or concussions to the fan.
- Do not put the fan under the power socket when using the fan.
- Do not use the fan in the sunshine.
- Put the power line correctly in case trip over by the cord.
- Put the fan on the flat and stable ground when using the fan
- Do not use the fan under the following situation: Near gaseous fuel cooker/ Place full of inflammable gas/ Place expose to rain or water pour/ Near insecticide/ Oil corrosive

solvent/ High temperature/ High humidity/ Near chemistry, oil, dust area

- Please do not pour water into the machine or hang wet clothes over the machine so as to avoid current leakage and electric shock; Please do not put flammable materials and wet clothes covered on the air outlet so as to avoid risk of fire or electric shock.
- Please do not spray solvent or flammable liquid to the fan as it may cause damage to the fan.
- Please shut down the machine before the user leave the machine so as to avoid accidents.
- Avoid continuously exposure of direct wind from the fan especially to infant and children.
- The power must be cut off and unplugged before cleaning or maintenance. Ensure that the fan is switched off from the supply main before removing guard/ cover.
- Please clean the machine by using a damp cloth or a damp cloth with some mild detergent, do not use corrosive detergent or solvent and such similar cleaning products, do not pour water into the machine.
- Please do not put the air intake and outlet of the fan close to the wall or curtain, otherwise the air flow will be blocked and affect the fan performance.
- If it occurs problems of abnormal sound or uneven wind speed after using for some time, perhaps there is too much

dust in the air intake grid and make the air flow blocked, the fan could get right by cleaning the fan with a plastic brush.

- Cut off the power if the unit is not used for a long period of time. Pull out the plug, pack the fan well to protect it away from dust and keep it in the dry, well-ventilated and clean place.

Parts name

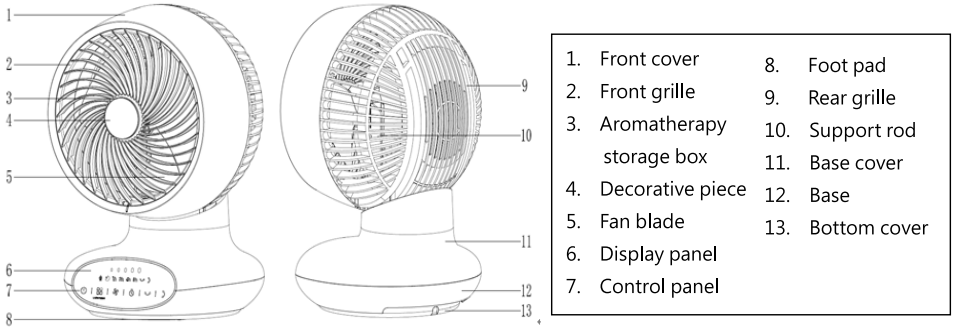

Control and display panel

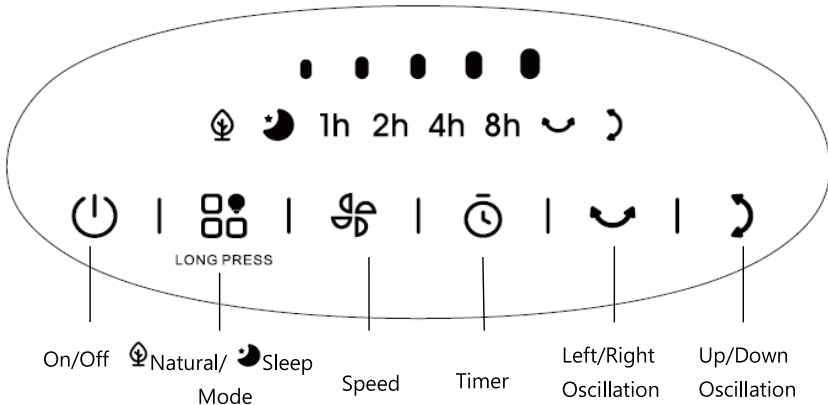

Remote control

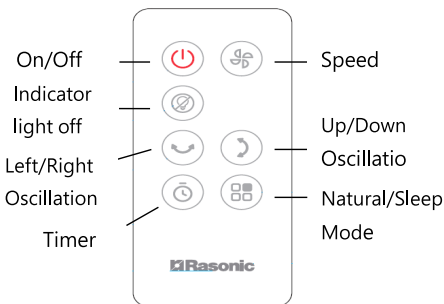

Battery replacement

- ① Pull out the battery case from the main body of the remote control and pull out the battery holder from the gap.
- ② Insert into the coin lithium battery, keep the positive pole upwards (CR2032).
- ③ After inserting the battery, slide the battery box, then insert and fix the battery box.

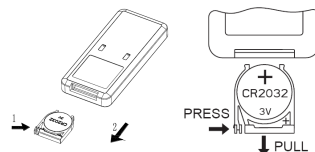

Cleaning and maintenance







- Always unplug the unit before cleaning, moving or servicing.
- Unplug the unit and wait until the fan stop running before cleaning.
- Do not immerse the power cord, plug and the whole unit into water or rinse under the tap.
- Do not use gasoline, benzene, thinner, poisonous or corrosive detergent to clean the unit to avoid damage of the appliance.
- Use a damp cloth to clean the surface of the fan.
- Dry the fan completely before use.
- When store, never wrap the power cord tightly around the appliance or put any pressure to the power cord so as to avoid power cord damage.
- Clean the fan every month.
- If the fan will not be used for a long time, store it in the cool, dry and safety place.

Disassembly of fan blade

- Please unscrew (in the bottom of the front cover) and turn the front cover in anti-clockwise direction. Take off the fan blade cover and take fan blade out for washing.
- While reinstalling the unit, please make sure fan blade is inserted completely, otherwise, the unit could not work properly.

Operation instruction

When plug in, the appliance with "Bi Bi" sound alerts, The fan is in stand-by mode. All the indicator lights are off.

	On/Off Press this button to turn on the fan. The default setting is in normal mode with level 2 wind speed. The indicator ● ● lights up accordingly. No oscillation and timer setting.
	Mode Choose Normal, Natural(☼) or Sleep(☾) mode. The fan is automatically defaulted in Normal mode once turn on. No indicator light for Normal mode.
	Speed Set your desirable fan speed (1 - 5 speed), and each indicator light represents one speed option. You can adjust the speed by pressing speed button.
	Timer Activate the timer (1 / 2 / 4 / 8 hours).
	Left/Right Oscillation Activate or deactivate horizontal oscillation of the fan.
	Up/Down Oscillation Activate or deactivate vertical oscillation of the fan.

Additional function

1. **Indicator Light Dimming/ Off Function** 

Indicator light dimming – After 60 seconds operation, all indicator lights dim.

Indicator light off – To turn off indicator light, press “Mode” button on control panel for 3 seconds or press  button on remote control.

2. **Memory Function**

The Fan has memory function in uninterruptible power on state. Without power off, when you turn on the unit again, it will operate the last setting before turn off. Sleep mode and timer function will not be memorized by the unit.

Aromatherapy storage box

1. Turn the aromatherapy cover in anti-clockwise direction (follow arrow 1 in the figure) and take it out (follow arrow 2 in the figure).
2. To drip a few drops of essential oil (do not drip in large amount to prevent spilling).
3. Snap the aromatherapy cover in clockwise direction to the original position.

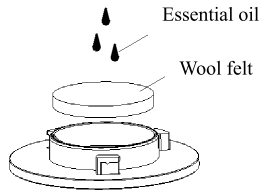
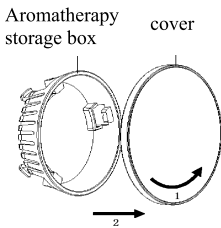

Specification

Model	RCF-6WL
Colour	White
Rated voltage	220-240V ~
Rated frequency	50Hz
Rated power	35W
Dimension (W x D x H)	186 x 200 x 290 mm
Net weight	2kg

Special avowal

1. The information above has been checked. Our company reserves the hermeneutic power to any printing errors or misunderstanding on the content.
2. If there are technical improvements on the appliance, the operation manual will be updated without any prior notice. The product appearance and color are subject to the actual appliance.
3. The e-copy of user manual can be sent by e-mail on requested, please call Shun Hing Electric Works & Engineering Co. Ltd. hotline at 2861 2767.

After sales services

For any defect, in the judgment of technician from Shun Hing Electric Service Centre Limited, caused under normal use, we are responsible for repairing or replacing parts of the said electrical appliance free of charge within one year guarantee period commencing from the date of purchase. Any defective part which has been replaced shall become our property. Guarantee service does not cover the repair or replacement of accessories, external cables or cabinet, etc. Additional charges shall be levied if services are required.

Please present the official invoice and the guarantee certificate with the sales point 's chop or the redemption center 's chop for free maintenance. For enquiries, please call Shun Hing Electric Service Centre Limited hotline at 2406 5666.

Free guarantee service will not be provided to the fan if: 1) it has been explicitly or implicitly modified, tampered with, altered or repaired in any way by persons other than technicians of the Company. Or 2) it has been damaged through misuse, negligence, liquid ingress or corrosion, power interruption, natural calamities or accident or external factors. Or 3) it is not a fixed installation on land. Or 4) the normal operation of the fan is affected by improper installation. Or 5) the domestic model of fan is used for industrial or commercial purpose. Or 6) the change of location or ownership of the fan and did not inform Shun Hing Electric Service Centre Limited.

信興電工工程有限公司

SHUN HING ELECTRIC WORKS & ENGINEERING CO., LTD

辦公室: 香港九龍尖沙咀東部麼地道 67 號半島中心 9 樓 909-912 室

OFFICE: ROOM 909-912, 9/F, PENINSULA CENTRE, 67 MODY ROAD, TSIMSHATSUI EAST, KOWLOON, HONG KONG

電話 TEL: (852) 2861 2767

傳真 FAX: (852) 2865 6706

網址 WEBSITE: www.rasonic.com

電郵 EMAIL: shew@shunhinggroup.com

保養及維修 MAINTENANCE AND REPAIR SERVICE

信興電器服務中心有限公司

SHUN HING ELECTRIC SERVICE CENTRE LTD.

辦公室: 香港新界葵涌勝耀街2號信興中心11樓

OFFICE: 11TH FLOOR, SHUN HING CENTRE, 2 SHING YIU STREET, KWAI CHUNG, NEW TERRITORIES, HONG KONG

電話 TEL: (852) 2406 5666

傳真 FAX: (852) 2408 0316

網址 WEBSITE: www.shesc.com

消耗品/附件銷售熱線 CONSUMABLES/ ACCESSORIES SALES HOTLINE

電話 TEL: (852) 2406 5666

客戶服務中心 CUSTOMER SERVICE CENTRES

香港新界葵涌勝耀街2號信興中心1樓

1ST FLOOR, SHUN HING CENTRE, 2 SHING YIU STREET, KWAI CHUNG, NEW TERRITORIES, HONG KONG

電話 TEL: (852) 2406 5439

傳真 FAX: (852) 2408 1389

澳門慕拉士大馬路193-199號南嶺工業大廈5樓1座

AVENIDA DE VENCESLAU DE MORAIS, NO. 193-199, 5 ANDAR-I, EDF. INDUSTRIAL NAM LENG, MACAU

電話 TEL: (853) 2836 2928

傳真 FAX: (853) 2833 6405

有關最新之客戶服務中心資訊, 請參閱信興服務中心網址: www.shesc.com或致電維修服務熱線查詢。

For the latest information of customer service centres, please visit www.shesc.com or call us at our hotline.