

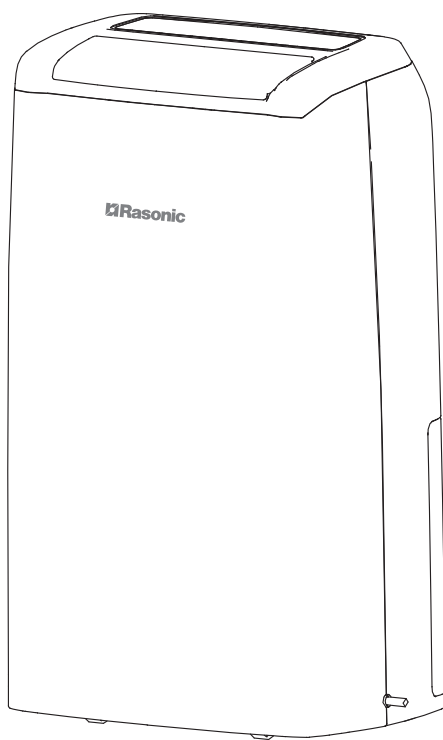

抽濕機

Dehumidifier

RPD-YL25U



目錄 Content

一 安全注意事項-----	1-4
二 使用環境-----	5
三 產品結構-----	6
四 使用方法-----	7-11
五 清潔及保養-----	12
六 故障排解-----	13-14
七 特別聲明-----	14
八 售後服務-----	15
九 產品規格-----	16
1. Safety Precautions-----	17-20
2. Operating Condition-----	21
3. Product Structure-----	22
4. Operating Introduction-----	23-28
5. Cleaning and Maintenance-----	29
6. Troubleshooting-----	30-31
7. Special Avowal-----	32
8. After Sales Services-----	32
9. Product Specification-----	33

僅適用於家庭使用
For Household Use Only

使用說明書

Instruction Manual

- 使用前，請仔細閱讀本說明書，並保存以便日後參考。
Please read this user manual before using the product and retain it for your future reference.
- 本說明書中所有的圖片僅供參考。
All the pictures in the manual are for reference only.

一 安全注意事項

 在使用本機之前，請務必詳細閱讀此說明書，並妥善保管，以便日後參考使用！

- 1) 不遵循或忽視這些安全注意事項會導致火災、觸電或個人傷害。
- 2) 使用本機前，請先核對供電電壓是否與本機相符，確認相符後方可使用。
- 3) 抽濕機為耗電量大的電器，應獨立接駁到一個固定插座，避免在同一個插座上插上其他電器，以免負荷過重。
- 4) 不要在浴室使用，可能導致觸電。
- 5) 不要將機器放置在能產生高溫家電附近，因為高溫可能損壞塑膠及引起火災；也不要再在陽光下暴曬，以免外殼脫色、變色。

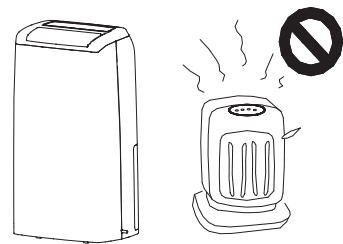

- 6) 不要在塵埃較大或有腐蝕性氣體，易燃易爆氣體的場所使用，以免發生危險。
- 7) 如與兒童一起使用，請給予適當的指導。請不要試圖拆卸，修改本機的配件。如發現抽濕機有損壞、不尋常的聲音、異味或震動時，為避免危險，請聯絡信興電器服務中心有限公司檢查及維修。
- 8) 把機器放在一個穩固，平坦的地面上使用，以防止產生振動和噪音。

- 9) 一旦機器傾倒，請立即拔掉電源
插頭。

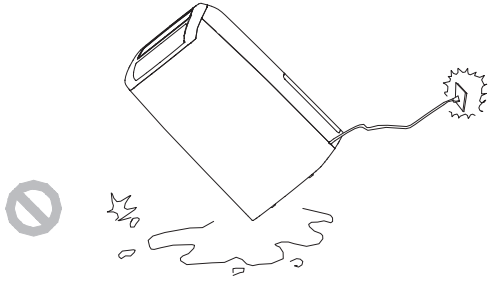

- 10) 機器運行時，不可覆蓋機體，以
免機器發生故障。



- 11) 不要阻擋進風口或出風口的空氣流動，以防止影響抽濕機性能或產生故障。
本設備使用時各面距離牆或者其他障礙物的安全距離是 30cm。切勿把抽濕
機置於狹窄而密閉的空間，例如衣櫃內使用，通風不良可能導致發熱及起火。

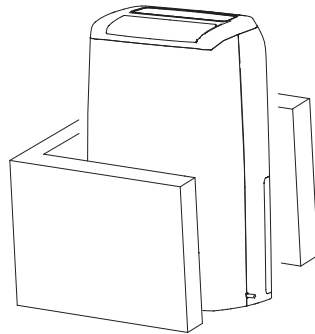

- 12) 不要直接噴水到機體上清洗，以
免引起機器故障和觸電。

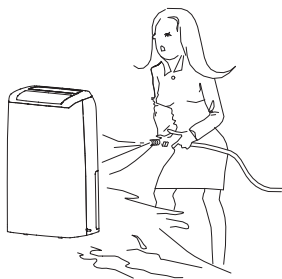

- 13) 手濕不要拔電源，否則可能
引起觸電和短路。

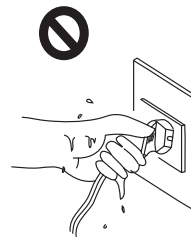

- 14) 拔出電源線插頭前要先關機，以免出現觸電或其他危險。

- 15) 若長時間不使用，請關機並拔掉電源線插頭，然後倒掉水箱裡的水並擦拭乾淨。

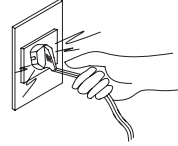

- 16) 不要拉線拔插頭，以免損壞電源線及造成事故。

- 17) 機器運行時，禁止用手及細小物件插入進風口或出風口內，以防止碰到裡面帶電部件和轉動的輪葉，損壞機器或造成危險。

- 18) 移動機器時，先拔出插頭及將水箱中的水倒掉，以免水濺出。

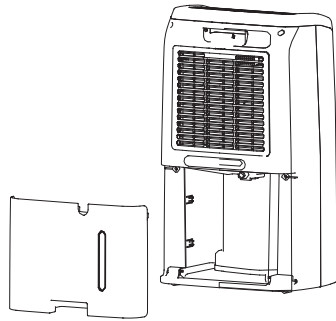

- 19) 在有人監督以及以安全的方法根據設備使用相關使用說明之指示下，此設備可由 8 歲以上的兒童使用，也可由 8 歲以上但體質、感覺或心智能力不足或是缺乏經驗與知識人士使用，但他們須了解相關的風險。兒童不應擅自把玩設備。不應由兒童獨自進行清潔與進行保養。

- 20) 此抽濕機不可由體質、感覺或心智能力有障礙或是缺乏經驗與知識人士使用，除非有負責其安全之人士的監督或是提供設備使用相關指示的情形下使用。

- 21) 若供電線受損，為避免危險，必須由信興電器服務中心有限公司進行更換

- 22) 如抽濕機有一段長時間沒有使用，必須先檢查後才可使用。

- 23) 請勿連接過壓電源或超負荷使用插座或拖板，否則可能引致電擊或設備過熱。

- 24) 請勿擅自拆卸或自行維修，否則可能會損壞機器或引致電擊。

- 25) 清洗產品前，請關閉電源拔出插頭，否則將會引致電擊或造成傷害。
- 26) 請勿飲用或使用回收水，否則水中有害物質將會危害您的身體健康。
- 27) 機器在運行過程中嚴禁拉出水箱，否則會引起水滿保護和電擊。
- 28) 將機器放置在穩固水平地面上，假如機器傾倒會使回收水灑出，從而損壞零件或引致電擊和發生火災。
- 29) 請勿將衣服、毛巾或任何物品遮擋機器排氣出風，否則會因為通風不流暢會導致過熱而引發火災。
- 30) 使用本產品時，需特別注意嬰幼兒、兒童、老人及對空氣濕度不敏感之人士。
- 31) 請勿在有化學物質揮發的環境下使用本產品，否則會被揮發在空氣中的化學氣體降低機器的性能。
- 32) 請勿在電源線上放置重物或用異物碾壓電源線，否則將會引致電擊或者引發火災。
- 33) 請勿在機器上放置花瓶或其他液體容器，否則液體會進入機器內部，導致機器損壞、觸電或火災。
- 34) 必須正確安裝空氣過濾網，並每兩周清洗一次不安裝過濾網或灰塵堵塞會導致機器運作故障。
- 35) 當有水進入機器時，請即關機並拔出插頭，否則將會導致機器故障或者引發事故。
- 36) 請勿攀爬或坐於本產品上，否則會導致跌傷、被壓傷或其他危險。
- 37) 請確保機器正確接地，以減少被電擊和避免火災。
- 38) 切勿讓抽濕機在無人看管下插上插蘇。不使用抽濕機時，須拔掉插頭。

二 使用環境

1. 除濕工作環境:溫度 5°C-35°C， 相對濕度 30%RH-90%RH
2. 本機只適合於室內環境使用，如客廳、臥室及辦公室等，切勿在室外使用。
3. 使用本機時，請確保所有門窗都已關閉，以達到最高效率。
4. 將機器放置在穩固、平坦的地面上使用，以免導致過大的震動而產生噪音。機體不可傾斜放置，以免除濕水溢出或機器傾倒。
5. 不可將抽濕機放在滴水的衣物下面使用。

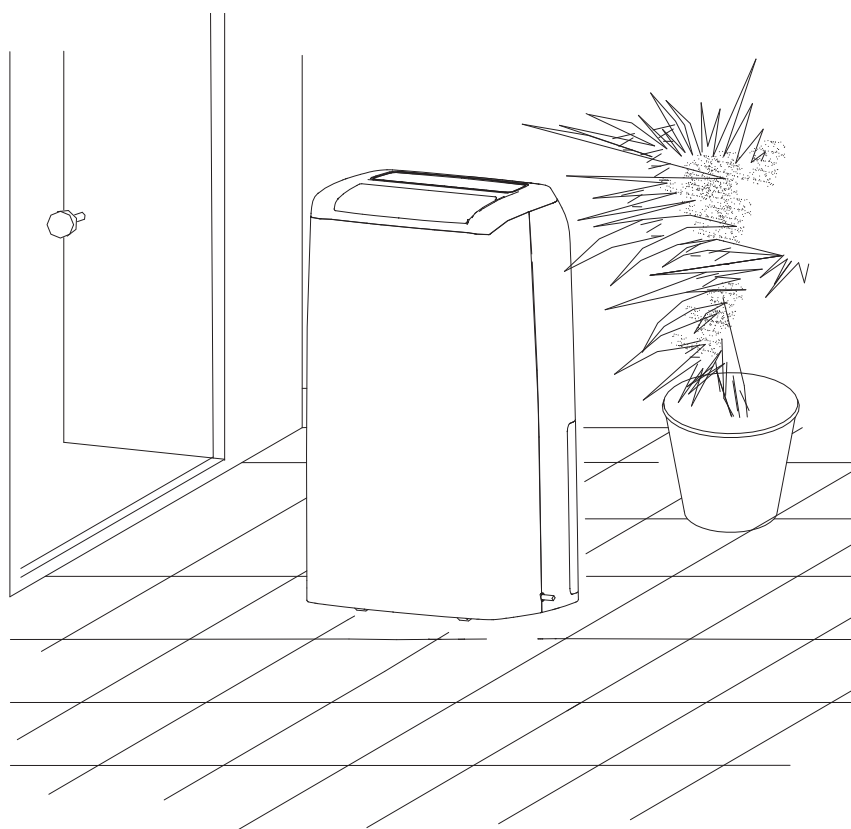

三 產品結構

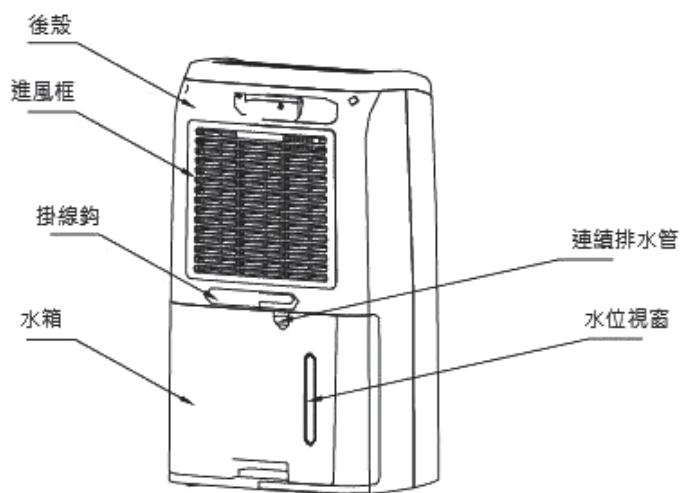
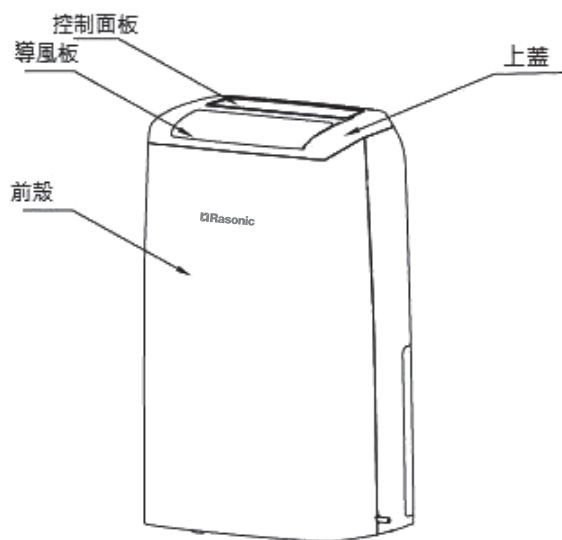

四 使用方法

(一) 控制面板

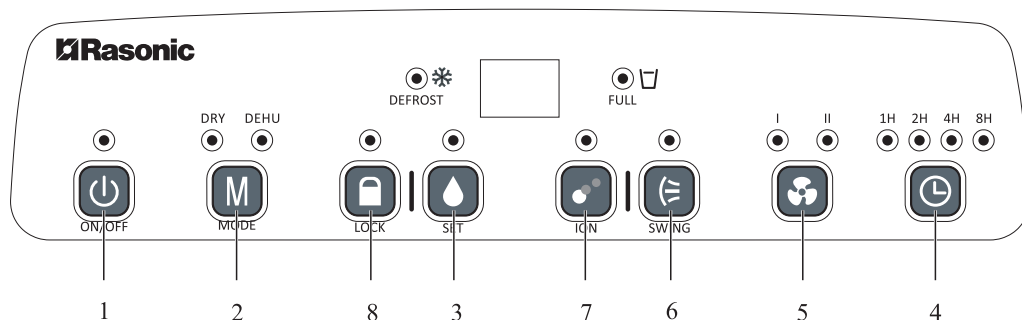



(二) 按鍵名稱及功能

- 1、 (開關鍵) : 此鍵可開、關機器
- 2、Mode (功能設置鍵) : 此鍵可設置乾衣 (Dry)、除濕 (Dehu)
- 3、Set (濕度設定鍵) : 此鍵可設置機器運行的濕度環境
- 4、Timer (定時鍵) : 此鍵可設置機器定時開關機時間
- 5、Speed (風速鍵) : 此鍵可調節風速 (Low 低、High 高)
- 6、Swing (搖擺鍵) : 此鍵可開、關自動擺風運行
- 7、Ion (負離子) : 此鍵可開、關負離子功能
- 8、Lock (童鎖鍵) : 長按此鍵 3 秒，可啟動、取消所有控制鍵的鎖控功能

(三) 按鍵操作說明

1. 開/關機鍵：當使用者把插頭插入插座後，蜂鳴器警示三聲。

開機： 按  開關鍵，機器啟動運行，導風片自動打開。機器在連續除濕模式工作，壓縮機工作和風扇在高檔運轉，負離子在工作。

關機： 機器在運行過程中，按  開關鍵，機器停止工作。

2. 功能設置鍵：可設置機器在除濕模式和乾衣模式工作

- (1) 按第一次功能設置鍵【Mode】，機器從除濕模式轉乾衣模式工作，同時除濕模式指示燈熄滅轉乾衣模式指示燈點亮，風扇高檔指示燈點亮；機器處於連續除濕 CO 功能工作，壓縮機工作和風扇在最高檔運轉。(注：在乾衣模式，按濕度鍵和風速鍵不起作用，也無蜂鳴聲。)
- (2) 按第二次功能設置鍵【Mode】，機器從乾衣模式轉除濕模式工作，同時乾衣模式指示燈熄滅轉除濕模式指示燈點亮，機器會按當前設置的濕度狀況進行工作，並且風扇在高檔或低檔運轉和壓縮機工作。(注：當在乾衣功能再次轉換到除濕功能時，抽濕機會記憶在除濕功能轉換為乾衣功能前的模式工作。)
- (3) 按第三次功能設置鍵【Mode】循環。

3. 童鎖鍵：

機器在工作狀態時，長按童鎖鍵【Lock】3 秒啟動童鎖功能，同時童鎖指示燈點亮，此時除童鎖鍵外按任何按鍵無效，也無蜂鳴器警示聲。若要解鎖，按住童鎖鍵 3 秒鐘會自動解除，同時童鎖指示燈熄滅。

- ## 4. 濕度設定：
- 在除濕功能時，按濕度設定鍵【Set】可設置：40%→50%→60%→70%→CO→40%→..... 在除濕功能時，當設置濕度值為 40%RH，數碼管上的設置濕度值會按當前設置濕度值不變，只顯示環境濕度值，若溫濕度感應器感應到環境濕度≤39%RH 時，壓縮機不工作，風扇馬達會在低檔運轉，電源指示燈長亮，當溫濕度感應器感應到環境濕度≥45%RH 時，壓縮機啟動工作，風扇馬達在設置檔位運轉，若分別設置濕度值為 50%RH、60%RH、70% RH，控制工作狀態類同以上 40%RH 時一樣。

5. **負離子鍵**：機器工作過程中，按負離子鍵【Ion】可設定負離子功能開啟或關閉，相對應的 LED 燈長亮或熄滅。
6. **搖擺鍵**：機器在工作時，按搖擺鍵【Swing】使擺風功能開啟或關閉，對應的指示燈在長亮或熄滅。
7. **風速鍵**：在除濕模式工作時，按風速鍵【Speed】可設置風扇在高檔或低檔運轉，並且高檔或低檔指示燈點亮。
8. **定時鍵**：
 - (1) 定時自動開機情況：



設定開機時間自動開機運行，按定時鍵【Timer】設定開機時間~1 小時~2 小時~4 小時~8 小時，如此循環選擇，同時對應指示燈點亮。
 - (2) 定時自動關機情況：

當機器運行時，按定時鍵【Timer】設定關機時間~1 小時~2 小時~4 小時~8 小時，如此循環選擇，同時對應指示燈點亮。

(四) 機器工作時水滿情況

抽濕機在工作時，若水箱水滿，壓縮機及風扇會暫停運作，同時蜂鳴器發出警示十聲，滿水指示燈和電源燈長亮。

(五) 記憶功能

- (1) 按  開關鍵關機後 (不拔掉機器電源插頭) , 抽濕機會進入待機模式 , 再重新按  開關鍵啟動抽濕機 , 會繼續以關機前工作模式運行。

注意：定時不適用於設置記憶功能。

- (2) 機器在工作時斷電 (即拔掉機器電源插頭或停電) , 當電力恢復 , 機器不會自動工作 , 按  開關鍵開機後機器按初始模式自動工作。

- (3) 定時結束時 , 童鎖自動取消。

(六) 自動除霜功能

當抽濕機處於低溫工作時 , 為保護製冷系統 , 自動除霜功能會啟動。若溫度感應器 (NTC) 感應到蒸發器的銅管溫度值低於或等於 -1°C 時 , 壓縮機連續工作 30 分鐘後 , 壓縮機停止 , 機器進行除霜 , 此時除霜指示燈【Defrost】在點亮。待溫度感應器感應到蒸發器的銅管溫度值高於或等於 2°C 和機器除霜時間多於或等於 10 分鐘 , 壓縮機才能啟動工作 , 然後機器開始除濕 , 並且除霜指示燈【Defrost】熄滅。

(七) 水滿自動停機功能

當機器設置除濕運行時 , 檢測到水箱水位達到設定高度 , 蜂鳴器將發出提示聲 , 同時整機停止運行。取出水箱 , 將水倒掉 , 再放回水箱 , 機器將按水滿前的設置狀態重新開機運行。(注意：放回水箱 3 分鐘後 , 除濕功能才會啟動。)

注：只有開啟除濕運行時才有此功能。

警告： 如果水箱滿水檢測浮標不潔或有異物，浮標不能隨水箱水位的上升而正常浮動，可能產生水箱水滿不停機，從而導致水流到地板上。請及時清洗水箱和浮標。

(八) 壓縮機保護功能

機器設置在除濕運行時，壓縮機停止工作後，如果立即再啟動，製冷系統壓力未平衡，容易引起超載保護啟動。機器設有壓縮機延時 3 分鐘啟動功能，在此 3 分鐘內，機器停止除濕。

(九) 雪種洩漏檢測：

當溫濕度感應器檢測到抽濕機的抽濕效能出現異常時，抽濕機會啟動雪種洩漏檢測及自動關機，只有數碼管上 C8 在閃爍，此時所有按鍵無作用，須重新通電才有效。

(十) 連續排水功能

當機器需連續排水時，用一根適合長度內徑 12mm 軟膠管通過後殼排水孔連接到排水嘴上，機器連續運行，水箱不會盛水。此時機器可連續運行而不會因水箱水滿而導致停機保護。

連續排水時，排水管末端需平放在地面。排水管的任何部位不可有折疊和上翹現象存在，否則可能會產生排水不順，甚至不排水的情形。

五 清潔及保養

清潔保養前，務必關機並拔出電源插頭。

1. 清潔機器及進出風口

- * 請用清水或中性洗滌劑，切勿使用有毒或含有腐蝕性的清潔劑。
- * 請勿將水灑在機器上，否則會引發短路、絕緣失效或零件鏽蝕。
- * 進出風口容易累積灰塵，請用吸塵器或者毛刷進行清理。

2. 清理水箱

- * 每隔幾周清洗一次水箱，以防發霉及滋生細菌。
- * 清洗時可加入適量的中性清潔劑或清水，均勻塗抹水箱內，然後沖洗乾淨。
清洗完畢後，請把水箱放回原位。

3. 清洗空氣過濾網

- * 空氣過濾網位於機器後面進風口處，請經常清洗或至少每 30 天清洗一次。
- * 如在灰塵多的環境中使用，則需加密清洗次數，防止因堵塞導致通風不暢而損壞機器。
- * 取出步驟：用手按濾網扣位向外拉出。
- * 裝回步驟：使濾網底端的兩個扣位對準機器上的扣位，在濾網頂部兩個扣位處向內壓。

六 故障排解

在要求售後服務前請先行查閱下表。

問題	待檢查事項
抽濕機無法啟動	<ul style="list-style-type: none"> <input type="checkbox"/> 確認抽濕機插頭完整插入插座中。 <input type="checkbox"/> 屋內無熔絲開關或保險絲是否斷掉? <input type="checkbox"/> 環境已達期預定濕度或是水箱已滿。 <input type="checkbox"/> 水箱未有正確位置。
抽濕機效能未如理想	<ul style="list-style-type: none"> <input type="checkbox"/> 沒有足夠時間移除濕氣。 <input type="checkbox"/> 確認沒有窗簾、百葉窗或是家具堵塞抽濕機前方或後方。 <input type="checkbox"/> 環境濕度比設定的低。 <input type="checkbox"/> 確認所有門、窗及其他開口處都已穩固關上。 <input type="checkbox"/> 室溫過低，低於 5°C (41°F) <input type="checkbox"/> 有煤油暖氣或是其他設備於室內散發水蒸氣。
裝置運作有巨大噪音	<ul style="list-style-type: none"> <input type="checkbox"/> 空氣濾網堵塞。 <input type="checkbox"/> 裝置傾斜而非擺放平穩。 <input type="checkbox"/> 放置的位置非水平。
蒸發器結霜	<ul style="list-style-type: none"> <input type="checkbox"/> 此為正常除霜。抽濕機啟動自動除霜功能。
漏水	<ul style="list-style-type: none"> <input type="checkbox"/> 水管與接頭或是水管接點可能鬆動。 <input type="checkbox"/> 設計是使用水箱集水，但背面排水插頭可能被移除。

顯示器中出現 錯誤代碼	C1	<input type="checkbox"/> 除霜溫度傳感器可能開路、短路， 拔出裝置插頭然後再次插上。 <input type="checkbox"/> 蒸發器溫度 $\geq 40^{\circ}\text{C}$ <input type="checkbox"/> 若持續發生錯誤，請聯絡信興電器 服務中心有限公司。
	C2	<input type="checkbox"/> 環境溫度傳感器可能開路、短路， 請拔出裝置插頭然後再次插上。 <input type="checkbox"/> 溫濕度感應電路板故障，請拔出裝 置插頭然後再次插上。 <input type="checkbox"/> 環境溫度 $\leq 0^{\circ}\text{C}/\geq 40^{\circ}\text{C}$ <input type="checkbox"/> 若持續發生錯誤，請聯絡信興電器 服務中心有限公司。
	C8	<input type="checkbox"/> 裝置偵測到雪種泄漏，請聯絡信興 電器服務中心有限公司。

如遵從以上方法處理仍然無法解決，應立即通停止使用並聯絡信興電器服務中心有限公司進行檢查及維修。

七 特別聲明

1. 本資料上所有內容經過認真核對，如有任何印刷及內容上的誤解，本公司將保留解釋權。
2. 本產品若有技術改進，會編進新版說明書中，恕不另行通知；產品外觀及顏色如有改動，則以實物為準。
3. 使用說明書的電子副本可以通過電子郵件發送致客戶。如有需要，請致電信興電工工程有限公司：28612767。

八 售後服務

由購買日期起之一年保修期內，經信興電器服務中心有限公司之服務人員證實乃在正常使用之情況下發生者，本公司將提供免費修理及更換零件。經更換之任何損壞零件，將歸屬本公司。保修範圍不包括修理或更換產品之附件、外接線及機殼等，如有需要服務時，用戶須另付費用。

用戶請於維修時出示購買收據 / 換購收據及保修證，如有任何疑問，請致電信興電器服務中心有限公司熱線查詢：2406 5666。

如在保修證內所列之電器：1)曾經被非本公司技術人員明顯地或非明顯地進行改裝、更改或修理；或 2)曾經被錯誤或不適當或疏忽使用、或因液體浸蝕、水濺、不正常供電、天災、意外或外來因素造成損壞；或 3)並非安裝在陸上固定地點；或 4)不當安裝位置影響正常操作；或 5)非工商業用型號產品，被用作工商業用途；或 6)用戶搬遷地址或更換物主而未能及時通知信興電器服務中心有限公司者，本保修證將自動失效。

九 產品規格

型號	RPD-YL25U
額定電壓	220-240 伏特~50 赫茲
抽濕量	14.9公升/每日 (26.7°C · 60%RH) 25 公升/每日 (30°C · 80%RH)
消耗功率	250 瓦特 (26.7°C · 60%RH)
製冷劑	R134a / 150 克
水箱容量	4 公升
尺寸規格 (闊×深×高)	346 × 242 × 590 毫米

1. Safety Precautions



Do not operate the unit before carefully reading this instruction guide.
Please keep this manual for product warranty and future reference.

- 1) Failure or negligence in observing these safety precautions could cause fire, electric shock or personal injury.
- 2) Please be sure your electricity is correct.
- 3) Use an independent socket for the appliance. Do not use extension cords to avoid overload and risk of fire and electric shock.
- 4) Please do not place the device near window or in bathroom prevent of electrical shock.
- 5) Please ensure the unit is not placed closely to the high temperature appliance in prevent of plastic destroying and fire.

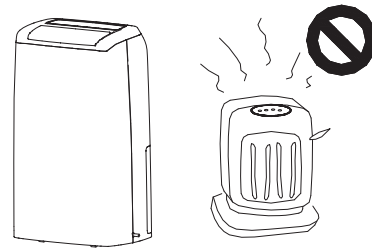
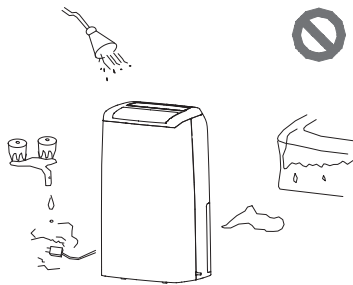

- 6) Never operate this unit in an explosive, corrosive or dusty atmosphere to avoid hazard.
- 7) Always guide if children operate. Never disassemble the unit to avoid hazard, if noise, odor and abnormal sound are found, please call Shun Hing Electric Service Centre Ltd. to check and repair the dehumidifier.
- 8) Operate this unit on a stable surface to avoid vibration and noise.
- 9) If toppled over, please pull out the plug at once.
- 10) Make sure outlet ventilation is not blocked at all times.

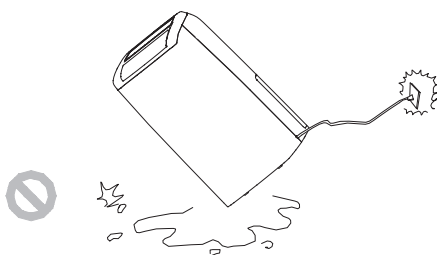

- 11) Ensure air intake and air outlet ventilation is not blocked at all times. Ensure there is 30 cm of clear space on all sides of the unit. Do not operate the appliance in narrow space such as wardrobes or cabinet. Poor ventilation may result in heat and fire.

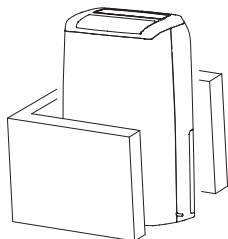

- 12) Do not spray water on the unit, spraying water may cause malfunctioning and electric shock.

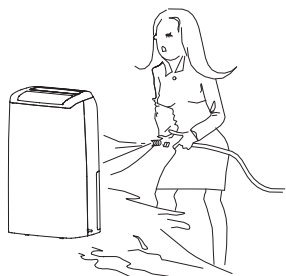

- 13) Never pull the socket by using damp hands, otherwise, it may cause electric shock.

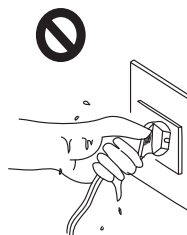

- 14) Always switch off at the appliance before unplugging to avoid electric shock or other hazards.

- 15) Switch off and unplug the unit, empty and clean the water reservoir when not using the unit for a long time.

- 16) Do not pull power cord by force because it will cause damage to power cord.

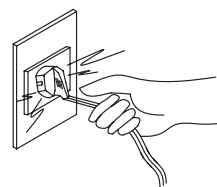

- 17) Never put fingers or other objects in any openings of the unit to avoid injury and product damage.

- 18) You must pay attention when moving the unit, empty the tank and unplug the appliance before moving.

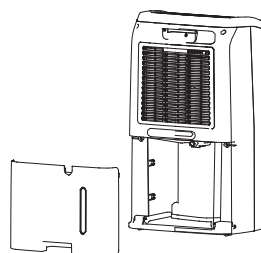

- 19) This appliance can be used by children aged from 8 years and above and persons with reduced physical, sensory or mental capabilities or lack of experience and knowledge if they have been given supervision or instruction concerning use of the appliance in a safe way and understand the hazards involved. Children shall not play the appliance. Cleaning and user maintenance shall not be made by children without supervision.
- 20) This appliance is not intended for use by persons (including children) with reduced physical, sensory or mental capabilities or lack of experience and knowledge, unless they have been given supervision or instruction concerning use of the appliance by a person responsible for their safety.
- 21) If the supply cord is damaged, it must be replaced by Shun Hing Electric Service Centre Ltd. in order to avoid a hazard.
- 22) Check the appliance carefully before ideal for a long time.
- 23) Do not exceed the rating of the power outlet or extension cord or connection device. Otherwise, it may cause electric shock or fire due to excess heat generation.
- 24) You should never try to take apart or repair the unit by yourself. It may cause failure of machine or electric shock.
- 25) Before cleaning, turn off the power and unplug the unit. It may cause electric shock or injury.
- 26) Do not drink or use the water drained from the unit. It contains contaminants and could make you sick.
- 27) Do not take the water bucket out during operation. It may trigger bucket full protection of the unit and cause electric shock.
- 28) Place the unit on a level, sturdy section of the floor. If the unit falls over, it may cause water to spill and damage belongings, or cause electrical shock or fire.
- 29) Do not cover the intake or exhaust openings with clothes, towels or other objects. A lack of air flow can lead to overheating and fire.
- 30) Care should be taken when using the unit in a room with the following persons: Infants, children, elderly people, and people not sensitive to humidity.
- 31) Do not use in areas where chemicals are handled. This will cause the unit deterioration due to chemicals and solvents dissolved in the air.

- 32) Do not place heavy object on the power cord and take care so that the cord is not compressed. There is danger of fire or electric shock.
- 33) Do not place flower vases or other water container on top of the unit. Water may spill inside the unit, causing insulation failure and electrical shock or fire.
- 34) Always insert the filters securely. Clean filter once every two weeks. Operation without filters and dust clog may cause failure.
- 35) If water enters the unit, turn off the unit and disconnect the power, otherwise, it may cause failure of appliance or accident.
- 36) Do not climb up on or sit on the unit. You may be injured if you fall or if the unit falls over.
- 37) Be sure the unit is properly grounded to minimize shock and fire hazards.
- 38) The dehumidifier must not be left unattended while it is connected to the supply main. Unplug when the appliance is not in use.

2. Operating Condition

1. Working condition:

Ambient temperature: 5°C - 35°C

Ambient humidity: 30%RH-90%RH

2. This device is only for indoor use e.g.: living room, bedroom, office etc.
Never use it in outdoors.
3. For the best efficiency and energy saving, make sure the door and window are closed before switching on the unit.
4. Ensure that the unit is placed on a stable and flat floor surface to prevent excessive vibration and noise. If the appliance tilted, it may cause water overflow and machine overturn.
5. Never place the unit under the dripping clothes.

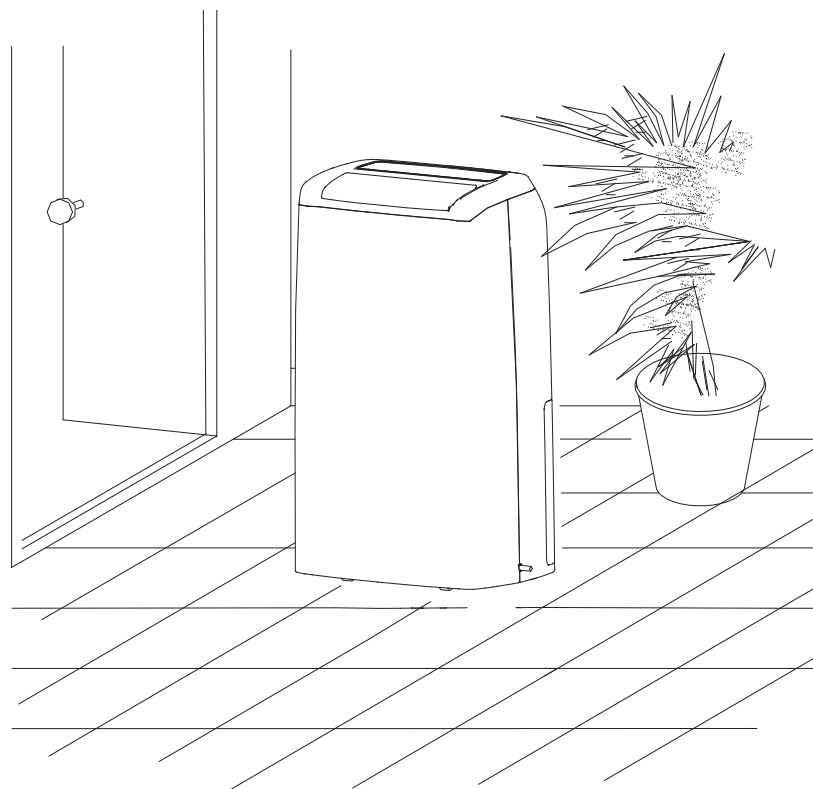

3. Product Structure

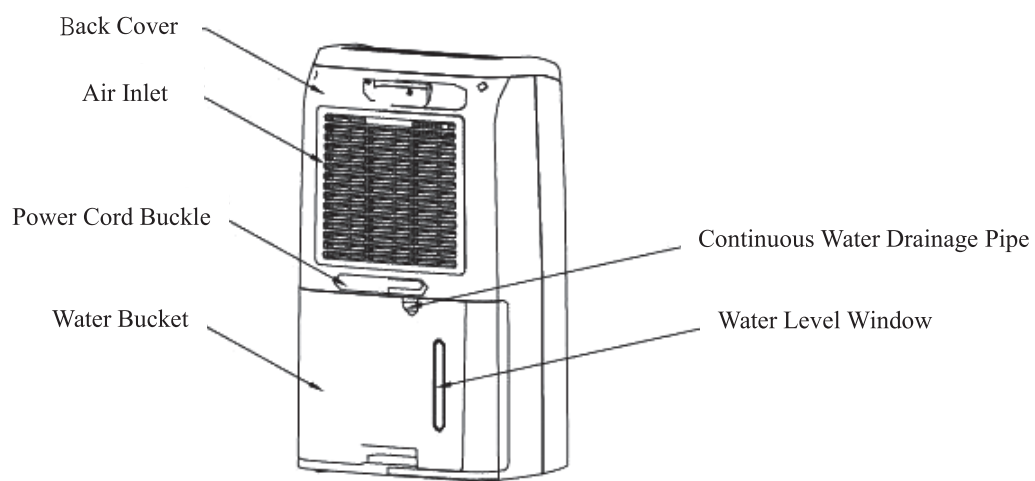
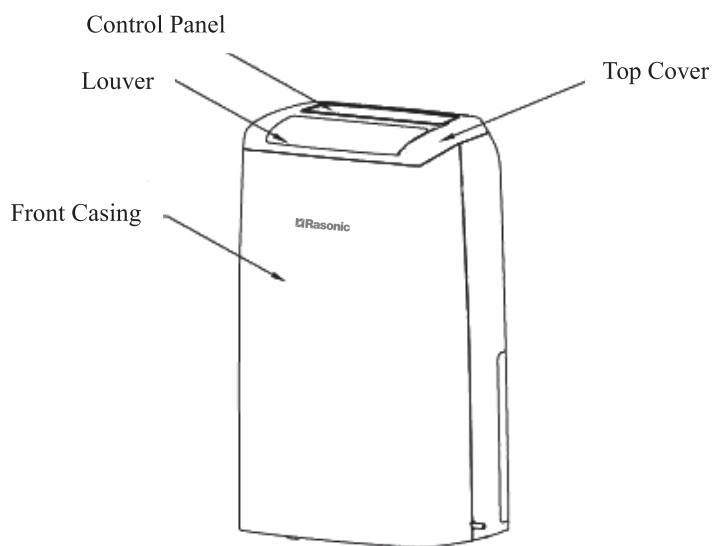

4. Operating Introduction

(1) Control Panel

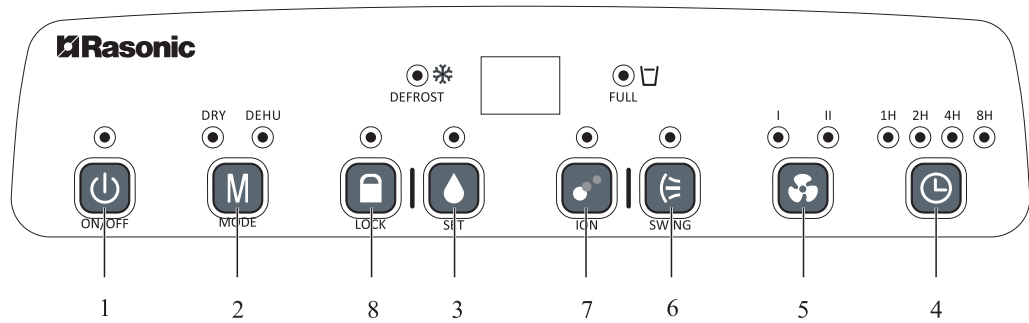

(2) Functions & Name of Key Pads

1.  (On/Off): Switch on/off the power
2. **Mode:** Press the button to set automatic drying (Dry) or dehumidification (Dehu)
3. **Set:** Press the button to set up humidity ranges of performance
4. **Timer:** Reserve & Turn off hours settings
5. **Speed:** Press the button to set up the air speed
6. **Swing:** Press the button to switch on/off swing performance (Low/High)
7. **Ion:** Press the button to turn on/off the ionizer function
8. **Lock (Child Lock):** Press the button for 3 seconds continuously to switch on/off all the lock function of the key pads

(3) Operation of Key Pads

1. **【 On/Off 】 button:** When user plug the device into power socket, 3 beep signals from buzzer can be heard.

On : Press  **【 On/Off 】** button to turn on the unit, the louver will open automatically.

The machine work at continue dehumidifying and fan at high speed running, ionizer function is working.

Off : When the machine is working, press the  **【 On/Off 】** button again to turn off the unit.

2. **【 Mode 】 button:** set dehumidifying or drying mode

(1) When user press the **【 Mode 】** button, the device will enter into drying mode from dehumidifying mode, the device works continue regardless of indoor humidity and the indicator light of “dry” and “high” speed fan will illuminate. (Noted: In the mode “dry”, there is no beep sound and no response when user press the button of humidity and fan speed.)

(2) When user press **【 Mode 】** button again, the device will switch into dehumidifying mode from drying mode, the indicator light of “dry” will extinguish and indicator light of “Dehu” will illuminate, device will work under before setting of humidity and fan speed (High or Low). (Noted: when the drying mode is switch into dehumidifying mode again, the device will memorize the previous setting before the dehumidifying mode switch into drying mode.)

(3) When user press **【 Mode 】** button again, cycle repeats.

3. Child Lock

Press the **【 Lock 】** button for 3 seconds to activate lock function. There is no response to press any other buttons unless deactivating LOCK function by pressing **【 Lock 】** again for 3 seconds.

4. Press the **【 Set 】** button to set desired humidity 40% → 50% → 60% → 70% → CO → 40% → Set the 40%--- expectations of ambient humidity value is 40%, when the appliance detects that the current ambient humidity is higher than or equal to 45%RH, the appliance starts and fan runs at high speed; when the appliance detects that the current ambient humidity is less than or equal to 39%RH, machine stop dehumidification and fan runs at low speed, the power indicator light will illuminate. It is similar to another humidity for 50% / 60% / 70%.

5. Ion

Press the **【 Ion 】** button to switch on/off ionizer function. Meanwhile, the dehumidification starts and the LED light illuminates.

6. Swing

When the machine is working, press **【 Swing 】** button to switch on/off swing function, the corresponding indicator light will illuminate or extinguish.

7. Speed

Press **【 Speed 】** button to select the fan working at “High speed” level or “Low speed” level. Meanwhile, the high or low speed indicator light is illuminating.

8. Timer

(1) Time reserved for operating:

Press **【Timer】** to set the reservation of operating for 1H/2H/4H/8H, timer symbol displayed on LCD screen.

(2) Time set for switching off:

Press **【Timer】** 1H/2H/4H/8H for power off, timer symbol displayed on LCD screen.

(4) Water Full

When tank is full, compressor and fan will automatically shut off and buzzer will alarm 10 times. Meanwhile, LED light of "power" and "tank full" will illuminate.

(5) Memory function



i. Press  **【On/Off】** button to switch off unit and device is in stand-by, the device will memorize the last setting if user turn on again.

Notice: Timer is not applicable in memory function.

ii. When power resume after power failure or electricity suspend, the machine cannot restart automatically and there is no memory function.

iii. "Child Lock" will be cancelled when the timer counting finish.

(6) Automatic Defrosting:

When the machine is working in low temperature, in order to protect cooling system, the automatic defrosting function will be activated. When the sensor detects the temperature of evaporator lower or equal to -1°C , the compressor will be continuously running for 30 minutes, then stop, the machine start defrost, the **【Defrost】** icon  lighten. When the sensor detects the temperature of evaporator higher or equal to 2°C and the defrost time longer or equal to 10 minutes, the auto-defrost mode end and the compressor start to work, the machine began to dehumidify, the **【Defrost】** icon  light off.

(7) Water tank full automatic stop function

When the device is set to operate in dehumidification mode, and the water level in the water tank reaches the preset height, the buzzer will alarm and the machine will stop. Take out the water tank and empty water, and then reinstall the water tank, the device will be resume the operation which is set before the water tank full. (The device will resume operation after the water tank is put back for 3 minutes.)

Note: This function is only available when the dehumidification operation is ON.

WARNING: If the water tank is full of dirty water or foreign objects, the buoys may not float normally as the water level in the water tank rises. This may cause the water tank to overflow and cause the water to flow to the floor. Please clean the tank and buoy in time.

(8) Compressor protection function

When the device is set in the dehumidification operation, and the compressor stops working, if it is restart immediately, the cooling system pressure is not balanced, this may lead to compressor protection function—that is, compressor will delay 3 minutes to restart. Within 3 minutes, the machine stops dehumidification.

(9) Refrigerant leakage detection function

The temperature sensor detect that device lost dehumidification, the refrigerant leakage protection function will be activated and shut off device automatically. Meantime, digital display “C8” digit flash and no response on all button unless turn on unit again.

(10) Continuous Drainage

When the machine needs to be drained continuously, connect the drainage hose of 12mm inner diameter to the drain outlet on the rear shell through drain nozzle. The machine will run continuously and the water tank will not be filled with water. At this point Water Tank Full Automatic Stop Function will not work.

When draining continuously, the drainage hose should be laid flat on the ground without folding or upturning. Otherwise, drainage may not be even or not drained.

5. Cleaning and Maintenance

Cautions: Make sure the unit is switched off before cleaning.

1. Clean the Grille and Case
 - * Use water and a mild detergent. Do not use poisonous or corrosive detergent.
 - * Do not splash water directly onto the main unit. Doing so may cause an electrical shock, the insulation to deteriorate or rusting.
 - * The air intake and outlet grilles get soiled easily, so use a vacuum cleaner or brush to clean.

2. Clean the bucket
 - * Clean the bucket to prevent growth of mold, mildew and bacteria in every few weeks.
 - * Partially fill the bucket with clean water and add a little mild detergent. Swish it around in the bucket, empty and rinse.

3. Clean the air filter
 - * The air filter behind the front grille should be checked and cleaned at least every 30 days or more often if necessary.
 - * Remove Procedure: Grip the tab on the filter and pull it outward.
 - * Reinstall Procedure: Aim 2pcs tabs at the bottom of filter to the machine's tabs, then press the 2pcs tabs at the top of filter.

6. Troubleshooting

Before calling for service, please review the chart below.

Problems	Checklist
Dehumidifier does not start	<ul style="list-style-type: none"> <input type="checkbox"/> Make sure the power plug is pushed completely into the outlet. <input type="checkbox"/> Check the fuse/circuit breaker box. <input type="checkbox"/> Dehumidifier has reached its pre-set level or bucket is full. <input type="checkbox"/> Water bucket is not in the proper position.
Poor performance of dehumidifying	<ul style="list-style-type: none"> <input type="checkbox"/> Did not allow enough time to remove the moisture. <input type="checkbox"/> Make sure there are no curtains, blinds or furniture blocking the front or back of the dehumidifier. <input type="checkbox"/> The ambient humidity may be lower than the humidity setting. <input type="checkbox"/> Check that all doors, windows and other openings are securely closed. <input type="checkbox"/> Room temperature is too low, below 5°C (41°F). <input type="checkbox"/> There is a kerosene heater or something giving off water vapor in the room.
Noise during operating	<ul style="list-style-type: none"> <input type="checkbox"/> The air filter is clogged. <input type="checkbox"/> The unit is tilted instead of upright as it should be. <input type="checkbox"/> The floor surface is not level.
Frost appears on the coil	<ul style="list-style-type: none"> <input type="checkbox"/> This is normal. The dehumidifier has auto defrost feature.
Water leakage	<ul style="list-style-type: none"> <input type="checkbox"/> Hose to connector or hose connection may be loose. <input type="checkbox"/> Intend to use the bucket to collect water, but the back drain plug is removed.

Error code shown on the display	C1	<input type="checkbox"/> Defrost temperature sensor may be short-circuited, unplug the unit and plug it back in. <input type="checkbox"/> evaporator temperature $\geq 40^{\circ}\text{C}$ <input type="checkbox"/> If error repeats, please contact Shun Hing Electric Service Centre Ltd.
	C2	<input type="checkbox"/> Temperature sensor may be short-circuited, unplug the unit and plug it back in. <input type="checkbox"/> Temperature and humidity sensing PCB board error, unplug the unit and plug it back in. <input type="checkbox"/> Ambient temperature $\leq 0^{\circ}\text{C}/\geq 40^{\circ}\text{C}$ <input type="checkbox"/> If error remains, please contact Shun Hing Electric Service Centre Ltd.
	C8	<input type="checkbox"/> Refrigerant leakage is detected, please contact Shun Hing Electric Service Centre Ltd.

If the above solutions cannot fix the problem, stop using immediately and contact Shun Hing Electric Service Centre Ltd to check and repair.

7. Special Avowal

1. The information above has been checked. Our company reserves the hermeneutic power to any printing errors or misunderstanding on the content.
2. If there are technical improvements on the appliance, the operation manual will be updated without any prior notice. The product appearance and color are subject to the actual appliance.
3. An electronic copy of the user manual can be emailed to the customer. If necessary, please call Shun Hing Electric Works & Engineering Co., Ltd.: 28612767.

8. After Sales Service

For any defect, in the judgment of technician from Shun Hing Electric Service Centre Limited, caused under normal use, we are responsible for repairing or replacing parts of the said electrical appliance free of charge within one year guarantee period commencing from the date of purchase. Any defective part which has been replaced shall become our property. Guarantee service does not cover the repair or replacement of accessories, external cables or cabinet, etc. Additional charges shall be levied if services are required.

Please present the official invoice and the guarantee certificate with the sales point's chop or the redemption center's chop for free maintenance. For enquiries, please call Shun Hing Electric Service Centre Limited hotline at 2406 5666.

Free guarantee service will not be provided to the unit if: 1) it has been explicitly or implicitly modified, tampered with, altered or repaired in any way by persons other than technicians of the Company. Or 2) it has been damaged through misuse, negligence, liquid ingress or corrosion, power interruption, natural calamities or accident or external factors. Or 3) it is not a fixed installation on land. Or 4) the normal operation of the unit is affected by improper installation. Or 5) the domestic model of unit is used for industrial or commercial purpose. Or 6) the change of location or ownership of the unit and did not inform Shun Hing Electric Service Centre Limited.

9. Product Specification

Model	RPD-YL25U
Rated voltage	220-240V~ 50Hz
Dehumidifying capacity	14.9L /day (26.7°C 60%RH) 25L /day (30°C 80%RH)
Power input	250W (26.7°C 60%RH)
Refrigerant	R134a / 150 g
Water tank capability	4L
Dimension (W X D X H)	346mm x 242mm x 590 mm

客戶服務中心 CUSTOMER SERVICE CENTRES

香港新界葵涌勝耀街2號信興中心1樓

1ST FLOOR, SHUN HING CENTRE, 2 SHING YIU STREET,
KWAI CHUNG, NEW TERRITORIES, HONG KONG

電話 TEL: (852) 2406 5439 傳真 FAX: (852) 2408 1389

澳門慕拉士大馬路193-199號南嶺工業大廈5樓I座

AVENIDA DE VENCESLAU DE MORAIS, NO. 193-199, 5 ANDAR-I, EDF.
INDUSTRIAL NAM LENG, MACAU

電話 TEL: (853) 2836 2928 傳真 FAX: (853) 2833 6405

有關最新之客戶服務中心資訊，請參閱信興服務中心網址：
www.shesc.com或致電維修服務熱線查詢。

For the latest information of customer service centres,
please visit www.shesc.com or call us at our hotline.

Rasonic 樂信牌

信興電工工程有限公司

SHUN HING ELECTRIC WORKS & ENGINEERING CO., LTD

辦公室: 香港九龍尖沙咀東部麼地道67號半島中心9樓909-912室

OFFICE: ROOM 909-912, 9/F, PENINSULA CENTRE, 67 MODY ROAD,
TSIMSHATSUI EAST, KOWLOON, HONG KONG

電話 TEL: (852) 2861 2767

傳真 FAX: (852) 2865 6706

網址 WEBSITE: www.rasonic.com

電郵 EMAIL: shew@shunhinggroup.com

保養及維修 MAINTENANCE AND REPAIR SERVICE

信興電器服務中心有限公司

SHUN HING ELECTRIC SERVICE CENTRE LTD.

辦公室: 香港新界葵涌勝耀街2號信興中心11樓

OFFICE: 11TH FLOOR, SHUN HING CENTRE, 2 SHING YIU STREET,
KWAI CHUNG, NEW TERRITORIES, HONG KONG

電話 TEL: (852) 2406 5666

傳真 FAX: (852) 2408 0316

網址 WEBSITE: www.shesc.com

消耗品/附件銷售熱線 CONSUMABLES/ ACCESSORIES SALES HOTLINE

電話 TEL: (852) 2406 5666



SHUN HING GROUP
信興集團
SINCE 1953

RPD/YL/2109