

Rasonic
樂信牌

使用說明書

INSTRUCTION
M A N U A L

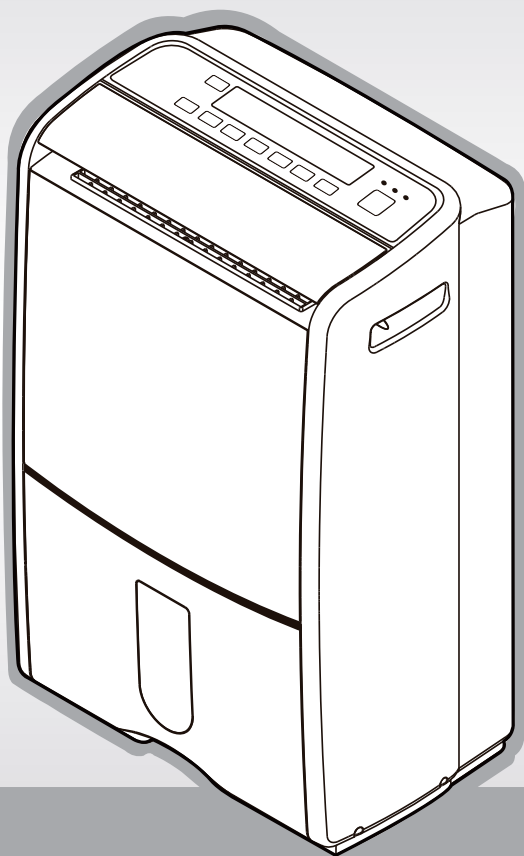

僅適用於家庭使用。
For household use only.

RPD-YS27GU

DEHUMIDIFIER 抽濕機

使用前請先詳細閱讀本說明書，並保存以便日後參考。

Please read this user manual before using the product and retain it for your future reference.



本說明書的圖示可能與實物有不同的地方，僅供參考。

Some figure in this manual may not match the real product, just for reference only.

安全使用說明

- 1.** 使用本抽濕機前請仔細閱讀相關說明，不當使用抽濕機會導致傷亡或財物損傷
- 2.** 使用前請先確定電源電壓
- 3.** 長時間不使用時務必將電線插頭從電源插座上拔掉
- 4.** 不要將布等物品覆蓋於出 / 入風口上
通風不良為發熱起火的原因。
- 5.** 請勿在密閉狹窄的地方運轉
(在衣櫃使用時，請將衣櫃門打開，並與衣物保持30cm以上距離，以免阻塞出 / 入風口。) 狹窄的空間裡運轉會因室溫上升而易造成故障。
- 6.** 請勿將手指或細棒等物體插入機體內部
- 7.** 勿背靠或乘坐於機體上
容易跌倒或機體傾倒引起意外傷害。
- 8.** 搬運時務必停止運轉並把水箱的水倒掉
- 9.** 勿將水濺入機體內
勿在易濺水的場所使用以免故障或漏電，清洗的衣物應脫水之後再晾乾，避免水滴滴在機體上。
- 10.** 切勿將機身、電源線或插頭浸入水中或用水淋洗，以免影響電器的安全性能及防止造成觸電的危險
- 11.** 勿噴灑殺蟲劑、可燃性噴霧劑，會損壞機體或引起意外傷害。
- 12.** 收藏時請勿橫放
否則會損傷機體或引起意外傷害。
- 13.** 請勿自行拆卸或修理機體
這會造成故障或引起意外傷害。
- 14.** 避免抽濕機操作時無人看管
- 15.** 在有人監督以及以安全的方法根據設備使用相關使用說明之指示下，此設備可由8歲以上的兒童使用，也可由8歲以上但體質、感覺或心智能力不足或是缺乏經驗與知識人士使用，但他們須了解相關的風險。兒童不應擅自把玩設備。不應由兒童獨自進行清潔與進行保養。

為了防止使用人及其他人的危害，誤用時可能會造成嚴重傷害及死亡等重大結果。
 忽略說明的內容而發生誤用所產生危害及損害的程度，以下列的表示來區分說明。

 警告	錯誤使用時，可能會造成嚴重傷害及死亡等重大結果。
 注意	錯誤使用時，可能會造成危險及傷害，或使物品受到損害。
 注意	本產品設計之安全使用年限為10年 若超過設計安全使用期限，因年久部品劣化及積灰塵和欠缺保養，導致發生起火等事故之可能性。

■ 請務必遵守下列內容，並以下列圖表示區分及說明。

	一般的禁止		必需遵行		禁止水淋		禁止加熱
	警告或提醒注意		拔除電源插頭		禁止潮濕手觸摸		禁止分解修理

 警告	
<p>不可改裝。此外，非修理技術人員絕不可分解及修理</p> <p>會造成火災、短路、故障或觸電受傷的意外事件。 如要修理或檢查，請聯絡信興電器服務中心有限公司。</p> <p style="text-align: center;"> 危險</p> <p style="text-align: center;"></p>	<p>勿將電源線損壞或使之破損、加工、過度彎曲、拉扯、扭轉或放置重物等動作</p> <p>會造成電源線破損導致火災或觸電受傷的意外事件。</p> <p style="text-align: center;"></p> <p style="text-align: center;"></p>
<p>保養時，務必將插座上的電線插頭拔起，此外手潮濕時不可拔插頭</p> <p>會造成觸電或受傷的意外事件。</p> <p style="text-align: center;"> 拔起電源插頭！</p> <p style="text-align: center;"></p>	<p>不可使用220V/15A以外的電壓</p> <p>會造成火災或觸電受傷的意外事件。</p> <p style="text-align: center;"></p> <p style="text-align: center;"></p>
<p>電源線及電源插頭損壞或鬆弛時，請勿使用</p> <p>會造成火花、短路或觸電的意外事件。</p> <p style="text-align: center;"></p> <p style="text-align: center;"></p>	<p>電線插頭的灰塵等要定期清潔</p> <p>插頭上若塵埃堆積，會因濕氣造成絕緣不良，引起火災的意外事件。</p> <p style="text-align: center;"></p> <p style="text-align: center;"></p>
 注意	
<p>使用前請確實將電源線插頭插好，及單獨使用220V的插座</p> <p>插頭須確實與插座緊密貼合，不可有鬆動或插入不完全的現象，否則會因發熱而引起火災的危險。</p> <p style="text-align: center;"></p> <p style="text-align: center;"></p>	<p>請勿放置在搖晃、傾斜等不牢固的場所</p> <p style="text-align: center;"></p> <p style="text-align: center;"> 危險</p> <p style="text-align: center;"></p>

為了防止使用人及其他人的危害，誤使用時可能會造成嚴重傷害及死亡等重大結果。忽略說明的內容而發生誤用所產生危害及損害的程度，以下列的表示來區分說明。

⚠ 注意

在拔插頭時不可拉電線拔起，一定要從插頭處拔起，會造成火花、短路或觸電的意外事件。



勿讓其吸入可燃性物品，點著的香線及香柱會產生火花的意外事件。

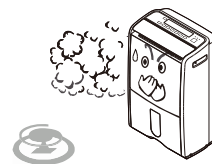

不可對之噴灑揮發油、塗料、殺蟲劑會造成觸電或火災的意外事件。

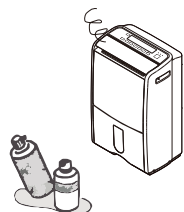

在機械油等油成份浮游處不得使用會造成龜裂或發生意外事件。



產品在長期開機運轉使用中，需有人員在場。如長期不使用、外出或夜間睡眠務必拔起電源插頭待機時仍有部份在通電狀態，會因絕緣劣化、觸電及漏電而造成火災的意外事件。拔起電源插頭可避免線路老化因而發生火災及可節約用電。

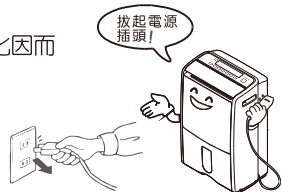

浴室等濕氣重的地方不要使用會造成故障及觸電受傷的意外事件。

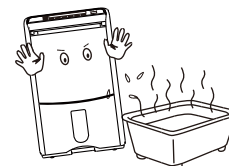

請勿使用多頭電源線插座

請勿使用延長線插座或與其他電器共用電源線，會有過熱而引起火災的危險。

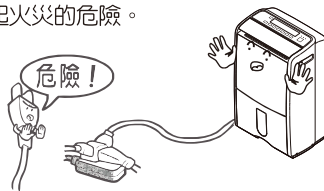

請勿使用破損之電源線或插頭

會造成火災、短路、故障或觸電受傷的意外事件。



請勿用潮濕的手拔取電源插頭或操作開關

潮濕的手會引起觸電。水會導電，易造成觸電。請務必用乾燥的手來拔取插頭。

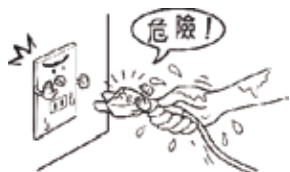

電源線請勿踐踏

電源線或插頭損傷是造成漏電、燒傷的原因，若電源線損壞時，必須聯絡製造商、販賣店或由專業人員更換，以避免危險。



各部名稱及功能說明

正面：

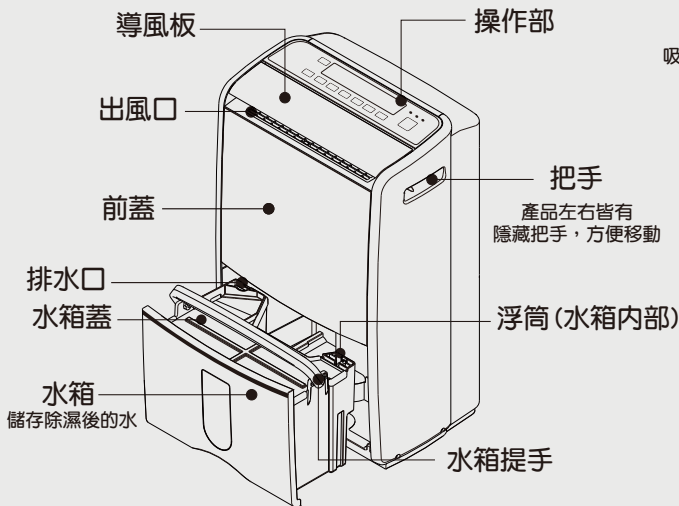

背面：

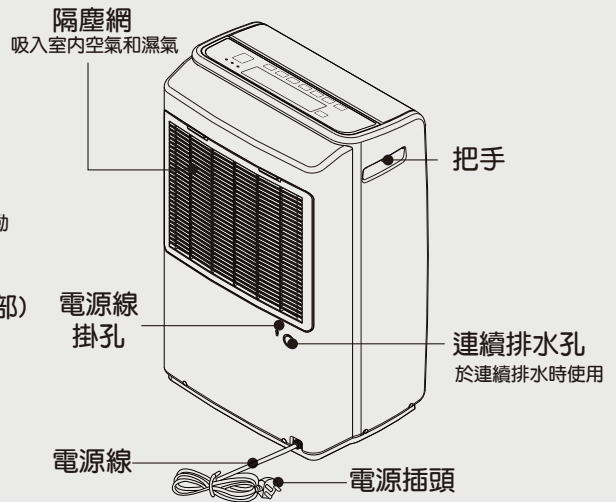

操作面板



操作說明及使用方法

操作面版：

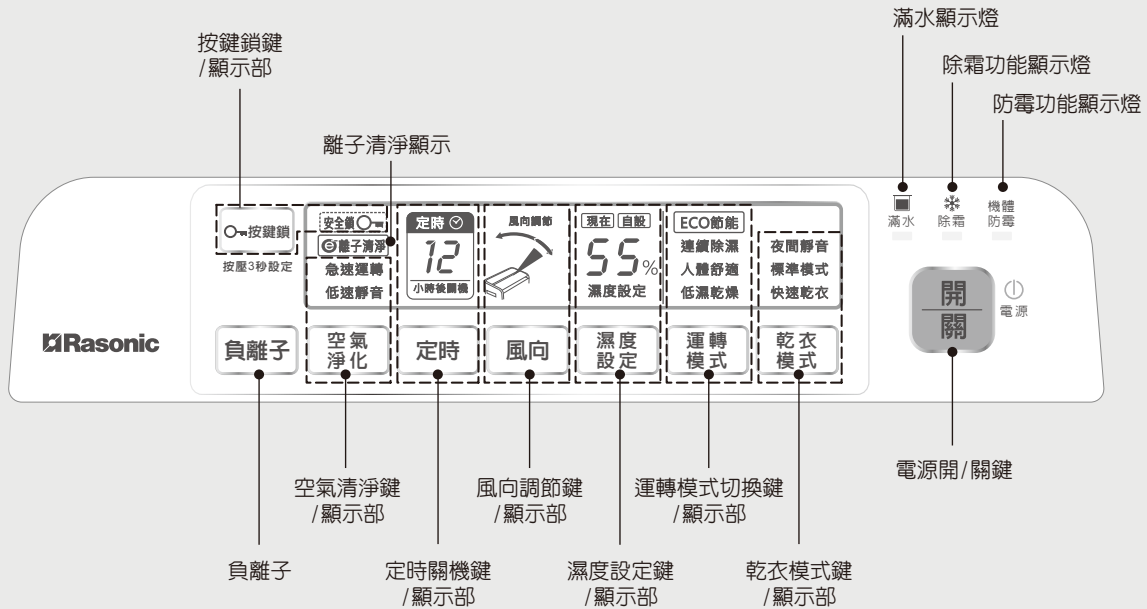

LCD顯示

- 開機中操作按鍵時,被選擇的功能會框起或顯示狀態,同時LCD背光會亮起,在停止操作後約10秒背光會自動熄滅。依據濕度偵測及機體狀況LCD背光會有不同狀態反應：
當偵測環境濕度H 大於 RH75%時LCD背光亮深藍色。
當偵測環境濕度H 大於或等於 RH65%時LCD背光亮淺藍色。
當偵測環境濕度H 小於 RH65%時LCD背光亮白色。
- 當移開水箱或滿水及發生傾倒狀況時，LCD背光會以閃爍深藍色光提示。
- 高濕度提示：在通電而關機狀態下，當偵測到環境濕度H 等於或大於 75%RH，LCD背光深藍色燈會亮起提示，如需關閉此功能可按下濕度設定鍵即可關閉燈號。

注意事項

- 若偵測環境濕度大於RH80%時[濕度顯示器]會顯示Hi，若小於RH45%時會顯示Lo。

[滿室] Hi % 濕度設定	大於RH80%	[滿室] Lo % 濕度設定	小於RH45%
----------------------	---------	----------------------	---------

- 當[滿水]指示燈亮起時，代表水箱內儲水已到滿水位或水箱尚未放置歸位，在此狀態下除開關機鍵可動作外，其他所有功能選項皆無法使用。
- 當[除霜]指示燈亮起時，代表機體正在進行除霜作業。壓縮機將停止運轉，風扇以高速運轉。
- 當[機體防霉]指示燈亮起時，代表為了避免機體內濕度過高出現發霉現象，風扇將會進行高速運轉送風3分鐘，若想停止此功能可在進入此功能後按[電源 開/關]鍵直接關機。

運轉操作說明

1 確認電源電壓後將插頭插入，濕度偵測將開始動作，當濕度高於RH75%時LCD背光(深藍色)亮起。

2 按電源按鍵，機體開始運轉，電源燈及濕度顯示亮起，並自動設定於ECO節能模式，如下圖所顯示狀況

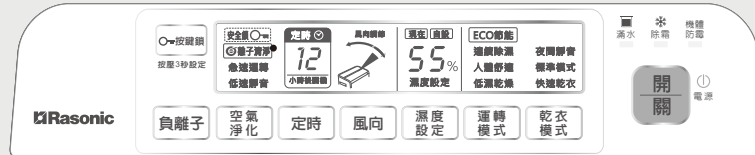

此時機體將按環境濕度狀況自動設定運轉狀態。當環境濕度大於RH50%，壓縮機將於電源鍵按下後三分鐘啟動除濕(但若插頭已連接電源超過三分鐘時，壓縮機將會立即啟動)。

3 若因應所需除濕狀況可設定運轉模式，請按運轉模式按鍵，此時會依照以下順序切換：

ECO節能 → 低濕乾燥 → 人體舒適 → 連續除濕



ECO節能：根據環境濕度狀況控制除濕能力並使環境濕度維持在50%RH~60%RH；而當環境濕度小於45%RH時則進入休眠狀態以節省電力。

低濕乾燥：機體運轉將環境濕度維持在RH50%以下。

人體舒適：機體運轉將環境濕度控制在最適合人體的狀況下。

連續除濕：機體在不控制濕度的情況下，持續運轉進行除濕，直到水箱滿水時或按下電源鍵關閉電源，才停止運轉。

4 若因應所需烘衣狀況可設定乾衣模式，請按乾衣模式按鍵，此時會依照以下順序切換：

標準模式 → 夜間靜音 → 快速乾衣



機體會按環境及溫度偵測控制運轉或自動停止。

標準模式：風扇以中速運轉，適合平時一般乾衣使用。

夜間靜音：風扇以低速運轉，適合晚間或睡眠時需要安靜的環境使用。

快速乾衣：風扇以高速運轉，適合需要在短時間內乾衣情況下使用。

- 乾衣模式下，機體最長運轉8小時後會自動關機。
- 若衣物仍未完全乾燥，請重新開機。

運轉操作說明

5 可自行設定濕度，按濕度設定鍵設定需求的環境濕度值後，會顯示設定的濕度值及 [自設] 字樣約4秒後，回復顯示目前的濕度值及 [現在] 字樣。

60% → 65% → 70% → 40% → 45% → 55%



濕度感應器可感測出目前所處環境濕度，並自動控制機體運轉使環境濕度維持所設定濕度。

6 當設定於空氣清淨按鍵，壓縮機停止運轉，風速可依需求照以下順序切換：

低速靜音 → 急速運轉



7 導風板開機後預設定位在45度，當按下風向調整鍵時，擺頭方式可依需求照以下順序切換有三種模式或停止：

下方向 (0~45度) → 上方向 (45度~90度) → 廣角式 (0~90度) → 擺頭停止

注意：導風板自動擺動時，不要扳動導風板。

8 按下定時關機鍵，可設定自動關機時間，定時時間有以下選擇：

OFF → 1hr → 2hrs → 3hrs → 4hrs → 5hrs...10hrs → 11hrs → 12hrs

隨定時時間減少LCD顯示時間會相對變化

9 當機體發生傾倒狀況時將自動停止所有功能運轉，濕度顯示器顯示Er並閃爍且機體狀態警示燈開始閃爍，並發出警示音提醒。待機體扶正後濕度顯示器顯示Er並持續閃爍。欲恢復機體運作需將電源拔除再復電(濕度顯示器顯示Er並閃爍)，重新啟動開關後需等待10分鐘壓縮機保護後(電源燈閃爍提示)，恢復正常狀態。



運轉操作說明

10 按鍵鎖定功能

當待機中或運轉中按住按鍵鎖鍵持續3秒後按鍵鎖啟動按鍵鎖顯示亮起，此時操作其他按鍵皆無效，若要解除此狀態需長壓按鍵鎖鍵3秒。

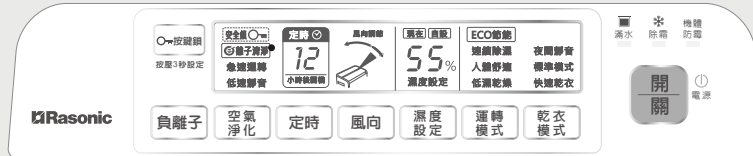

11 空氣淨化功能

在機體運轉狀態下按負離子鍵可開啓或關閉負離子清淨功能。當負離子清淨燈亮起，機體會釋放負離子淨化空氣。

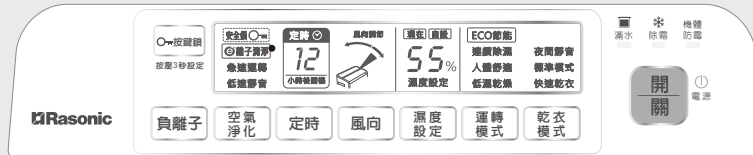

12 產品的適用溫度範圍

請在下列的室溫使用，若超過這個溫度範圍而連續運轉的話，會造成機器負擔而無法運轉，請注意使用環境溫度範圍。

使用範圍
5 ~ 35°C

特點功能說明

1 搬運便利

機體兩側有隱藏式把手以及底部附加輪子，可輕鬆搬運至所需空間。

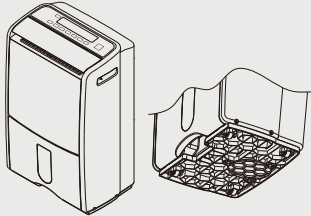

2 定時關機功能 (1~12小時)

休息前或外出時設定關機時間，時間到自動關機節省電又安全。



3 LCD運轉功能及環境濕度顯示



4 三段式電動導風板

透過三段式電動導風板，可依需求選擇下方向、上方向或廣角式風向。

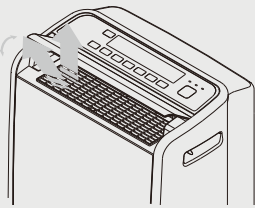

5 ECO節能除濕

全自動控制機體之運轉及停止，以維持環境濕度在60%-50%之間，方便又省電。



6 超大容量水箱

充分使用空間以增加水箱儲水量(容量6公升)，約滿5公升時自動停止運轉。

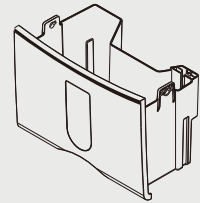

7

下雨天清洗衣物更容易乾燥



8

減低天花板和牆壁潮濕發霉

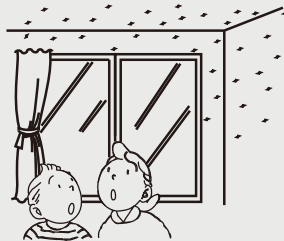

9

除去榻榻米或地毯的濕氣

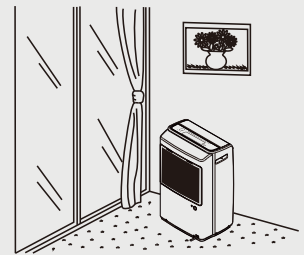

10

壁櫥等的除濕

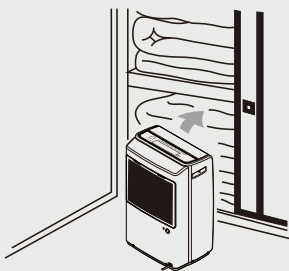

請打開衣櫥的門或抽屜再運轉機器

11

預防衣物或皮革製品發霉

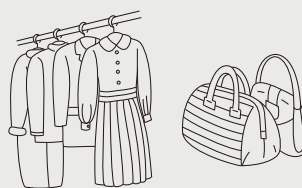

請打開衣櫥的門或抽屜再運轉機器

12

適合對於濕氣較敏感的樂器

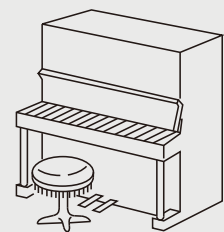

排水的操作方法說明

當水箱內的水儲存約5公升的水量時，運轉會自動停止，且

1.滿水燈亮起 2.警示燈閃爍，請倒掉水箱內的水。

1 取出水箱

將手指置入水箱下方之凹槽處，並輕輕拉出水箱。

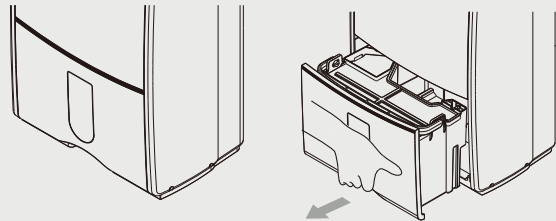

2 倒水方法

1. 手持水箱把手至排水處
2. 手持水箱把手及托住底部排水。
排水時須注意浮筒磁石是否正常，如遺失除濕機將無法正常動作。
3. 將把手押回原位。

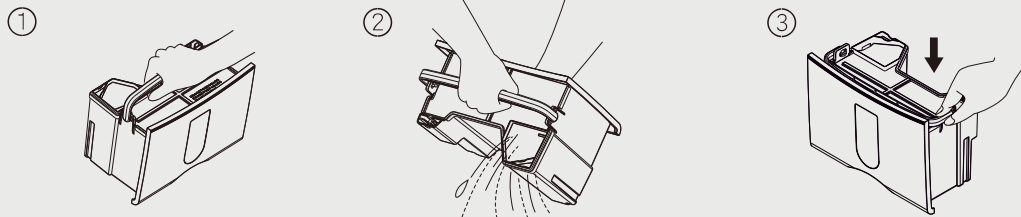

3 裝入水箱

將水箱放入機體定位，滿水燈熄滅，機體即恢復原始運轉狀況。

4 勿取發泡膠

請勿隨意取出或丟棄此水箱內的浮球發泡膠，否則會造成水滿功能失效。

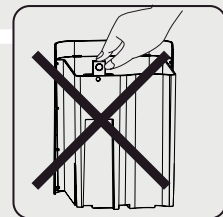

注意事項

- ◎水滿停機時請不要立刻取出水箱，因殘留於機體內的除濕水會再滴落。
- ◎移動機體時請停止運轉，並將除濕水倒掉，以避免水箱內的水濺入機體或濺濕地板。
- ◎在低溫狀態下由於蒸發器的除濕水容易結霜之故，可能會產生水箱內不滴入除濕水的情形，並不是故障的現象。
- ◎除濕水之出水孔要保持暢通，以免除濕水無法排出。
- ◎水箱內之保麗龍浮筒附有磁石，為水滿停機與啟動運轉之訊號感應重要依據，請勿隨意拆卸或拔除，否則無法正常運轉。

連續排水的操作說明

使用連續排水時，請如下操作：(※警告：如長期使用都無人看守，請勿採用此方法)

1 請用工具將背面的連續排水孔打開

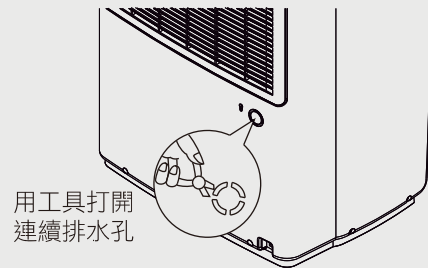

2 請將排水管穿過連續排水孔，排水彎頭套在排水管上
排水管請自行購買內徑13~15mm的軟質水管。

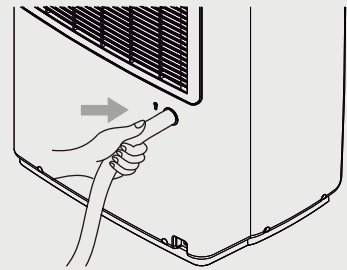

3 將排水彎頭接駁排水口

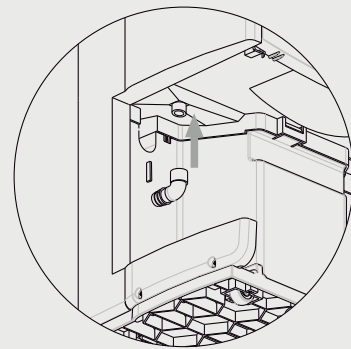

4 將水箱裝回原來位置

若沒有把水箱裝妥將無法運轉。

保養方法須知

★請定期檢查及保養機器，使機器更持久耐用，保養時請停止機體運轉，並將插頭從插座上拔掉。

入風口的清理

若灰塵或塵埃積存在隔塵網，將影響除濕能力或引起故障，請每2週左右清洗一次

1 請先取下隔塵網。

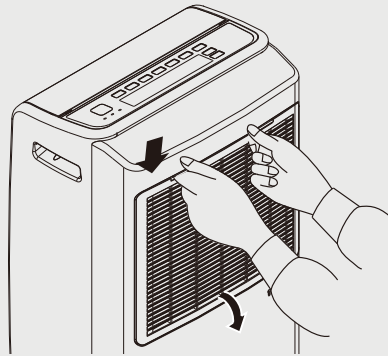

2 將隔塵網以水或吸塵器清除隔塵網上的灰塵，若用水洗時請放在陰涼處自然吹乾。



用吸塵器時
將積有灰塵的面向上

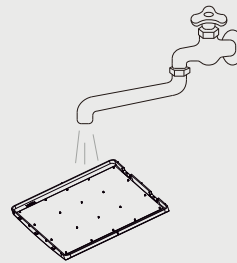

水洗時
將積有灰塵的面向下

3 將隔塵網裝回原來位置。
(隔塵網須完全晾乾再裝回，以免水滴被吸入影響機器運轉。)

注意事項

- ◎ 隔塵網不要用40℃以上的水清洗或放在日光下曬以避免濾網變形。
- ◎ 隔塵網清洗後一定要裝回去，以免塵埃進入機體內引起故障。

保養方法須知

機體的清理：

- 1 用溫水（40°C以下）沾濕或用沾有中性洗潔劑的軟布擦拭。
- 2 使用中性洗潔劑後一定要再用乾淨的水擦拭。

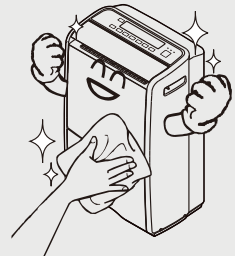

- 3 除濕機內若進水會造成絕緣性不良，和生鏽等情形，擦拭電氣部位時請儘量擰乾濕布。

- 4 下列的物品請勿使用，以避免侵蝕塑膠外殼。
塗料調薄劑、揮發油、酒精、石油、洗衣粉、亮光粉、強鹼洗潔劑、熱水、酸溶液、毛刷等。

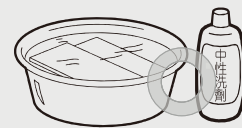

- 5 若使用含有化學藥品的抹布磨擦或長時間接觸於機體可能會對機體造成損壞請注意。

貯存：

1. 將殘留於水箱內的水全部倒掉，擦乾水箱。
2. 將插頭自插座拔下，使用收線帶將電源線捲起收納在機體背面的收線固定孔上。
3. 清理隔塵網。
4. 在機體完全乾燥後，套上簡便的防塵套，並放在不會被日光直接照射到且通風良好的地方。

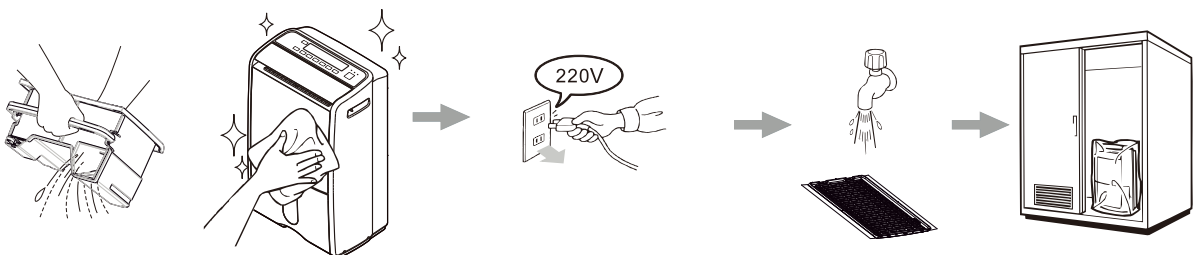

光觸媒濾網使用說明

1. 光觸媒濾網裝置前請拆除塑膠袋。
2. 先取下入風口蓋，將濾網確實嵌入裝配固定點。
3. 使用光觸媒濾網時，將使除濕能力降低約3-5%。
4. 清洗光觸媒濾網時，請先關閉電源開關。
5. 光觸媒濾網清洗(壽命約5年，半年清洗一次)
將光觸媒濾網組取下，置於水龍頭下沖洗後，置於太陽下晾乾約6小時即可。切勿將光觸媒濾網以肥皂溶液清洗或將濾網自框架取下清洗擰乾，以免損壞濾網。

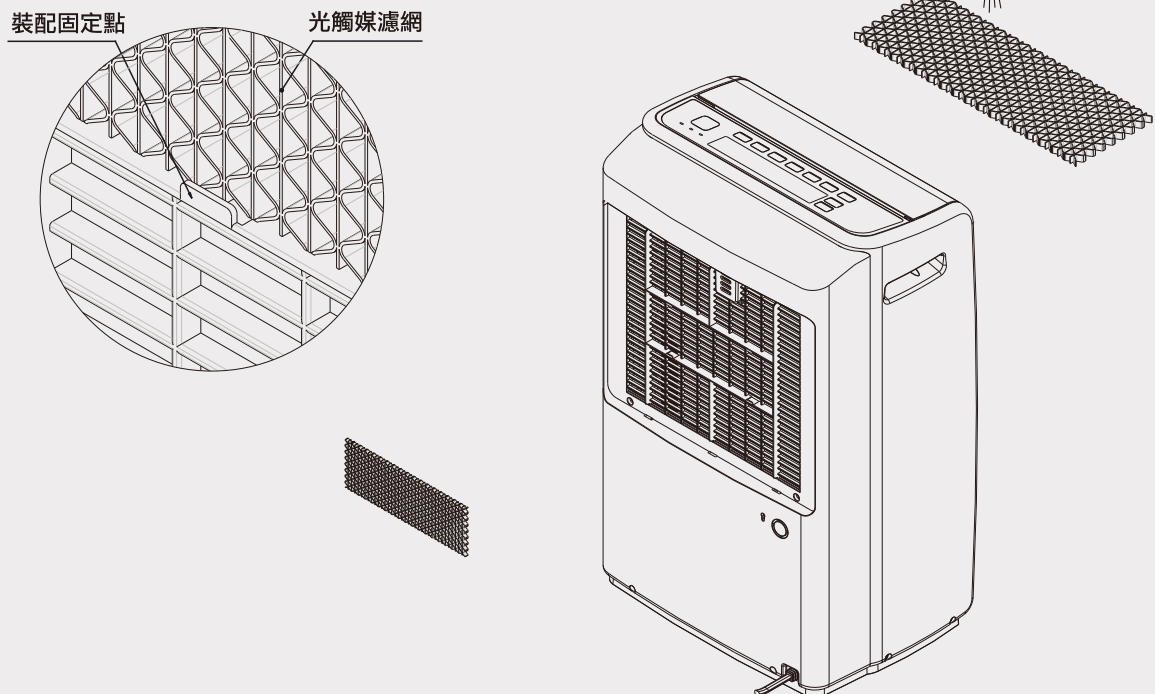

- 使用方法及環境條件會影響濾網壽命。
- 光觸媒濾網是一般耗材,請定期更換。
使用期滿或損壞,請洽服務中心購買。

規格

型 號	RPD-YS27GU
額 定 電 壓	220-240V~ 50Hz
額 定 除 濕 能 力	14.9 公升 / 日 (26.7°C、RH60%) 27 公升 / 日 (30°C、RH80%)
額 定 消 耗 功 率	265W
額 定 運 轉 電 流	1.25A
冷 媒 種 類	R134a
冷 媒 填 充 量	350g
水 箱 容 量	6L (5L 時 自 動 停 止)
淨 重	15.8kg
外 型 尺 寸	高 600 × 寬 370 × 深 263 (mm)

注意

抽濕量視乎室內環境的濕度和溫度。

若電源線損壞時，必須交由信興電器服務中心有限公司維修，以避免危險。

一般電器產品並不是為體質，感覺或智力有障礙人士(包括小孩)，或缺乏經驗及知識者使用，除非他們曾經接受負責安全人士的監督或指示。

請小心看管小孩，以確保他們不會把此抽濕機當作玩具。

自購買起一年內，若產品在正常使用的情況下發生故障，可免費享有本公司提供的維修服務。

用戶請於維修時出示購買收據，如有任何疑問，請致電信興電器服務中心有限公司熱線查詢：2406 5666。

特別聲明

1. 本資料上所有內容經過認真核對，如有任何印刷及內容上的誤解，本公司將保留解釋權。
2. 本產品若有技術改進，會編進新版說明書中，恕不另行通知；產品外觀及顏色如有改動，則以實物為準。
3. 使用說明書的電子副本可以通過電子郵件發送致客戶，如有需要，請致電信興電工工程有限公司：28612767。

故障排除及緊急處理方法

- 請在要求售後服務前再仔細檢查以下各點。

狀 況	檢 查 事 項
① 按電源ON鍵仍不運轉	① 水箱是否放置正確？ ② 水箱內的水是否滿了？ ③ 電線插頭是否插好？ ④ 屋內無熔絲開關或保險絲是否斷掉？ ⑤ 是否停電？
② 除 濕 量 少	① 前置空氣過濾網是否阻塞？ ② 出風口、入風口是否阻塞？ ③ 室內溫度、濕度是否過低？
③ 漏 水	① 排水管阻塞？ ② 水箱放置不當？ ③ 水箱破裂？
④ 濕 度 不 易 降 下	① 室內空間是否太大？ ② 門、窗的開關次數是否過多？ ③ 室內是否有產生水蒸氣的物品？
⑤ 噪 音 太 大 時	① 除濕機是否放置不當引起噪音？ ② 地板是否不平？
⑥ 風 吹 不 出 來	① 是否過濾網阻塞？

緊急處理方法：

- 萬一本產品發生異常時，請先將電源開關關掉，再將電源插頭拔掉。
- 如故障問題未能解除，請聯絡信興電器服務中心有限公司檢查或維修。

Important safeguards



1. Read all instructions carefully before using. Hazards that may cause death, injury or property damages from misuse.
2. Be sure of correct voltage is used and plug is well plugged in socket.
3. Remove plug from socket for cleaning maintenance or storage.
4. To avoid dangerous, please do not cover inlet/outlet with cloth or curtain. Poor ventilation may cause fire.
5. Please do not operate dehumidifier in a closed or narrow space.
(when the dehumidifier is used in the closet, please keep the door of closet open and keep clothing away from air inlet and outlet at least 30 cm, to avoid obstruction of air inlet and outlet.)
A closed or narrow space may cause circumstance temperature raised up and damage machine.
6. Please do not insert finger, nail or metal rod in the unit.
7. Do not stand on or lean against the unit. This may cause it to fall over, resulting in personal injury.
8. Before moving the unit, please empty water and remove plug from socket.
9. To avoid short circuit or leakage, please don't spray water on the unit.
10. Never immerse the body, power cord and plug in water or let them wet, in order to avoid functional damage to the appliance electric shock.
11. Do not spray solvent or flammable liquid.
12. Do not lay down the unit as which may damage the unit and cause noisy.
13. When the unit is out of order please do not intend to disassemble the unit.
14. Avoid leaving an operating dehumidifier unattended.
15. This appliance can be used by children aged from 8 years and above and persons with reduced physical, sensory or mental capabilities or lack of experience and knowledge if they have been given supervision or instruction concerning use of the appliance in a safe way and understand the hazards involved. Children shall not play the appliance. Cleaning and user maintenance shall not be made by children without supervision.

WARNING









- This appliance can be used by children aged from 8 years and above and persons with reduced physical, sensory or mental capabilities or lack of experience and knowledge if they have been given supervision or instruction concerning use of the appliance in a safe way and understand the hazards involved.
- Children shall not play with the appliance.
- Cleaning and user maintenance shall not be made by children without supervision.
- If the supply cord is damaged, it must be replaced by the manufacturer or its service agent or a similarly qualified person in order to avoid a hazard.







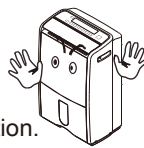

Safety precautions

To prevent users and others injury or damage, please follow all the instructions below. Ignoring the symbols incorrect operation can result in harm or level of damage, described in the following two categories.

 WARNING	Improper handling may lead to serious injury or even death.
 CAUTION	Improper handling may lead to injury or property damage.
 CAUTION	The product designed useful life is ten years. If product exceeds useful life, parts may deteriorated, dust accumulation or lack of maintenance, in some circumstances cause fire.

■ This icon used in this manual the following.

	Never do		Be sure to follow the instructions		Do not wet		Keep away from flames
	Caution or Notice		Disconnect the power plug		Do not handle with wet hands		Prohibit disassembling

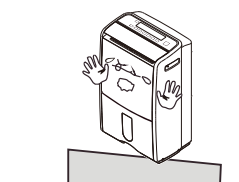
 WARNING	
<p>Do not modify or disassemble the unit by yourself .</p> <p>Improper handling may lead to fire, short circuit, electric shocks or injury. Please contact Shun Hing Electric Service Centre Limited for check and repair if any part is damaged or malfunction.</p> 	<p>Do not damage, remodel, bend unreasonably, pull, twist or place heavy objects on power cord.</p> <p>Using damaged power cord, fire or electric shocks may occur.</p> 
<p>Disconnect power cord before cleaning, maintenance or moving the unit.</p> <p>Do not pull out the power plug with wet hand, electric shocks may occur.</p> 	<p>Use only a 220V-240V power supply.</p> <p>Other power supplies may lead to fire or electric shock.</p> 
<p>Do not use the unit when the power supply cord or the power plug is damaged or plugged loosely into an electrical socket.</p> <p>A damaged or loose cord or plug may lead to fire because of a electric shock or short circuit. Periodically clean the dust and dirt from the plug with a dry cloth.</p> 	<p>Accumulation of dust and foreign objects may cause insulation failure and lead to fire</p> 
 CAUTION	
<p>Insert the power plug into the electrical socket completely.</p> <p>Incomplete connections may lead to electric shock or fire because of overheating.</p> 	<p>Do not use the unit on an uneven floor.</p> 

Safety precautions

To prevent users and others injury or damage, please follow all the instructions below. Ignoring the symbols incorrect operation can result in harm or level of damage, described in the following two categories.

⚠ CAUTION

Do not unplug roughly.

Pulling on the power supply cord may cause fire, short circuit or electric shock.

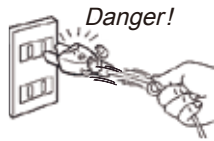

Do not use unit near flammable gas.

If flammable gas permeates the surrounding space, it may cause fire.



Do not spray volatile substances, i.e., gasoline, solvent, insecticide.

It may cause fire or electric shock.



Do not use the unit anywhere there is airborne oil such as machine oil.

Airborne oil may lead to cracking or ignition.



Before long period of disuse, disconnect the power plug from the electrical socket.

Degraded insulation may lead to electric shock, current leaks or fire.

The dehumidifier must not be left unattended while it connected to the supply cord.



Do not use the unit in the place of water may splash onto the unit

Avoid the product damage or electric shock.

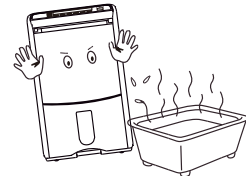

Do not use an extension power cord.

It may result in overheating and fire.

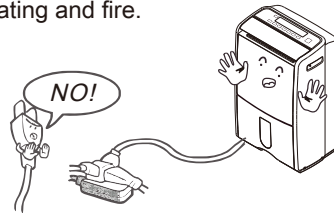

Do not use damaged power cord or plug.

It may cause electric shock, short-circuit or fire.



Do not pull out the power plug with wet hands.

Electric shocks may occur.



Do not trample on the cord as this may cause damage.

If the power supply cord is damaged, it must be replaced by the manufacturer, dealer or qualified persons in order to avoid hazard.



Product Description

Front View :

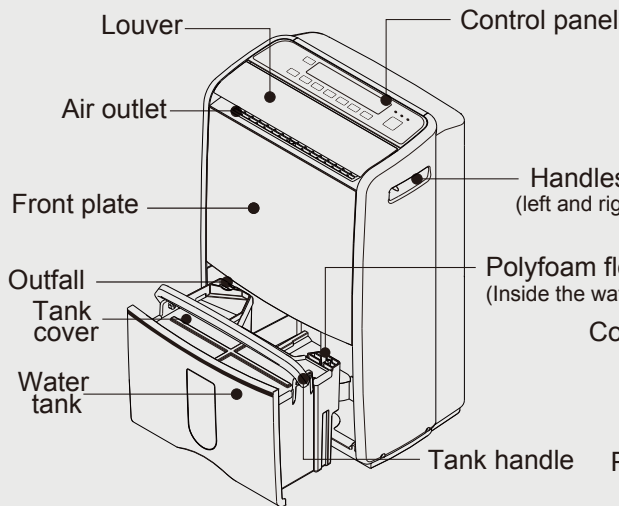

Rear View :

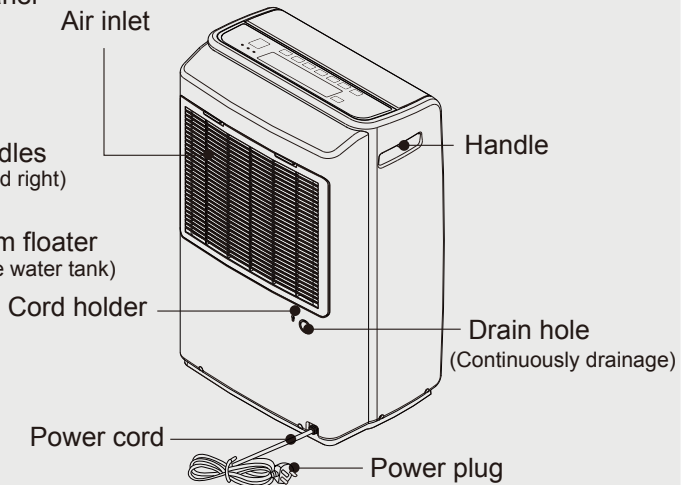

Control Panel :



How to use

Control Panel :

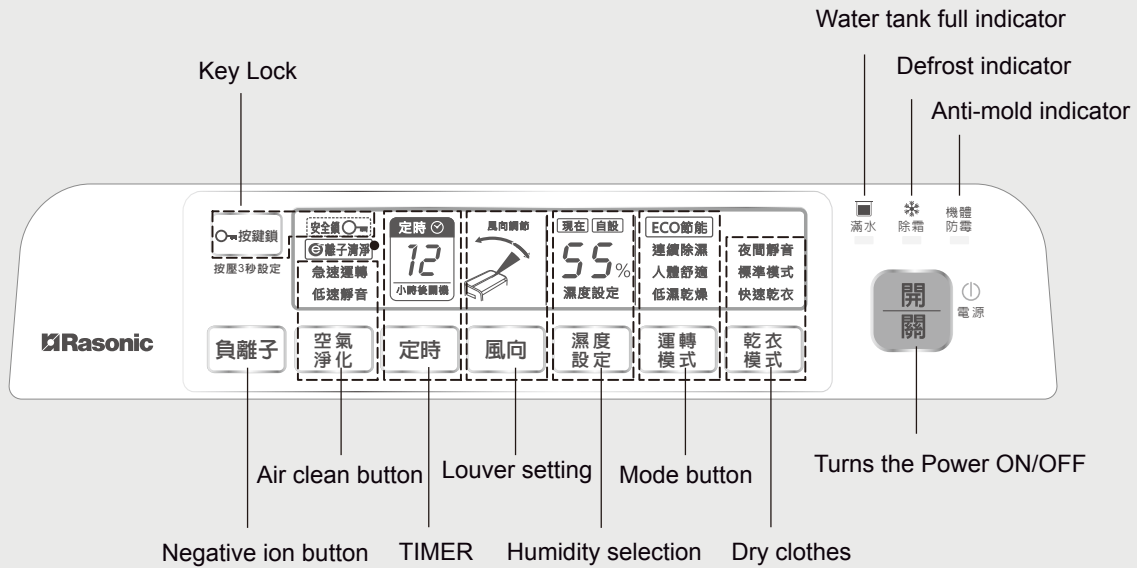

Note

★ Current Humidity Display

If ambient humidity is greater than RH80% [Current humidity display] will display Hi, if less than RH45% will display Lo

★ Water Tank Full indicator

Water Full Tank indicator light up, operation will stop automatically if tank is not emptied or it is not in the proper place.

★ Defrost indicator

When the Defrost indicator light up, this indicates the unit is in the defrost mode. (Unit operates at high speed with compressor off)

★ Anti-mold indicator

When Anti mold indicator light up, unit will operate at high speed fan automatically for 3 minutes; press "Power ON/OFF" button can stop function immediately.

LCD Panel :

All indicators on the LCD Panel shown below:

Frame appears around selected mode

Press any button when the power is on, selected function will be displayed. Meanwhile, the LCD backlight lights up, and the backlight will automatically go off after 10 seconds.

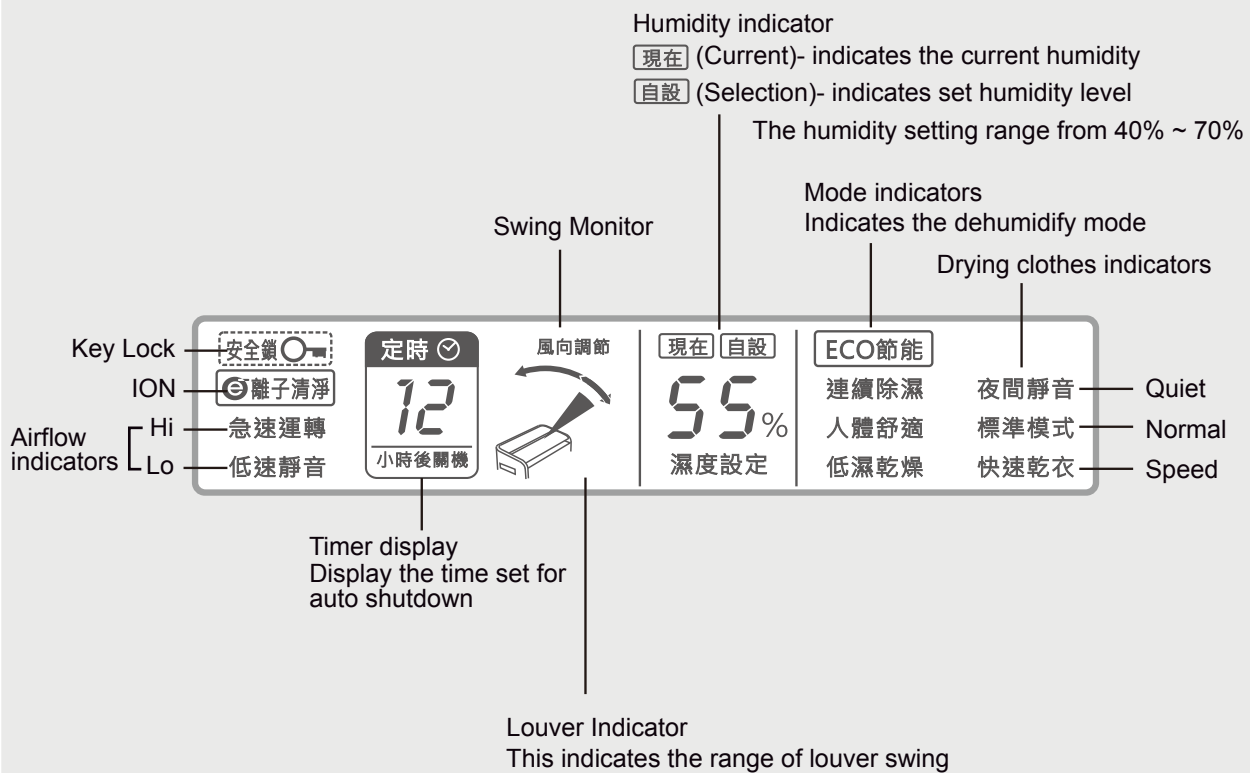

LCD Backlight indicator different ambient humidity and unit condition:

1. Deep Blue: Ambient humidity is greater than RH75%
2. Light blue: Ambient humidity is greater than or equal to RH65%
3. Brightening: Ambient humidity is less than RH65%
4. Deep blue backlight keep flashing: When the unit is tipped over, water tank is full or not place in the right position.
5. High ambient humidity indicator: During standby, when unit detects ambient humidity more than 75%, deep blue backlight will light up. Press "Humidity button" can turn off the indicator light.

How to use

- 1 Be sure of correct voltage is used and plug is well plugged in socket. The unit automatically detects ambient humidity, when room humidity more than RH75% and LCD backlight will light up.(Deep Blue)

- 2 Press "開/關(ON/OFF)" button to start the unit and the Power and Humidity indicator light turn on. Unit operates at "ECO節能(ECO)" mode automatically set as below situation:



Unit operates at "ECO節能(ECO)" , according to room humidity. When room humidity is over RH50%, compressor will turn on in 3 minutes after the"開/關(ON/OFF)" button is pressed .

(When the plug is connected to power more than three minutes, the compressor will start immediately)

- 3 You can adjust the dehumidification mode according to the actual situation, press "模式運轉(Mode)" button to switch to other function:

ECO節能(ECO) → 低濕乾燥(Dry) → 人體舒適(Comfort) → 連續除濕(Continue)



ECO節能(ECO) : Select "ECO節能"(ECO) mode, unit operates automatically with low energy consumption and keep humidity level between 50% ~ 60% ; or operates at low speed(compressor is off) when humidity is less than 45%.

低濕乾燥(Dry):Unit operates continually to maintain ambient humidity level under 50%.

人體舒適(Comfort):Unit operates continuously to keep ambient humidity at a suitable level for human body.

連續除濕(Continue):Unit operates continuously dehumidification regardless of the ambient humidity level until water tank full or Power button is pressed.

- 4 You can adjust the "乾衣模式(Dry clothes)"mode by press"乾衣模式(Dry clothes)"button to switch to other function: 標準模式(Standard) → 夜間靜音(Quiet) → 快速乾衣(Speed)



The unit turn on/off the fan and compressor automatically according to the ambient humidity and temperature.

標準模式(Standard):Select"標準模式(Standard)" mode, unit operates at middle speed fan to dry clothes in energy saving.

夜間靜音(Quiet):Select"夜間靜音(Quiet)" mode, unit operates at low speed fan and suitable for night time or sleeping.

快速乾衣(Speed):Select"快速乾衣(Speed)" mode, unit operates at high speed fan to dry clothes quickly.

- The unit operates for 8 hours and automatically switches off.
- Restart the unit if it turns off before the laundry dries.

How to use

5

Humidity Selection

Pressing the button once displays the set humidity level with the [自設] (Selection) indicator. After 4 seconds, the display returns to the current humidity display and shows the word [現在] (Current)

60% → 65% → 70% → 40% → 45% → 55%

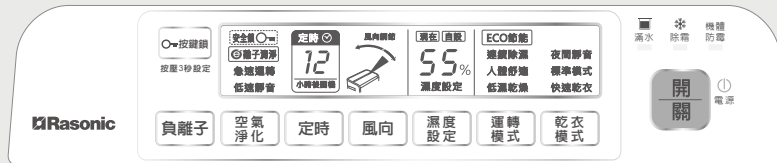

Humidity sensor detects the ambient level and keeps indoor humidity at the set humidity.

6

Select "空氣淨化(Air Clean)" mode, press to select low or high air volume, and compressor is off.

低速靜音 (Low speed) → 急速運轉 (High speed)



7

Louver Setting

When power is on, the direction of the louver is inclined at 45 degree. Press "風向(Louver)" button to select the louver swing range.

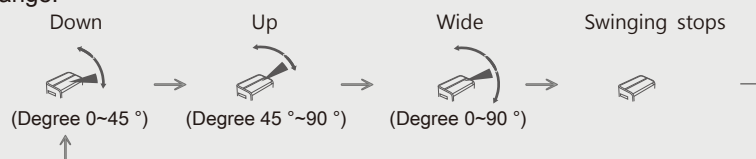

Note: Do not move the louver while swinging operation is in progress.

8

Press "定時(Timer)" button to select the shutdown timer.

OFF → 1 hr → 2 hrs → 3 hrs → 4 hrs → 5 hrs...10 hrs → 11 hrs → 12 hrs

After timer is set, unit will display time remaining.

9

When unit is tipped over, operation will stop automatically, Humidity Indicator is flashing and alarm.

1. Disconnect the power cord
2. Place the unit in an upright position on a stable, flat surface
3. Insert the power cord again and restart the unit
(Compressor starts once the plug plugged in the socket after 10 minutes)



How to use

10

• Key Lock setting

During standby or operation, please press "按鍵鎖(Key Lock)" button for 3 seconds to activate the Key Lock. When the LCD Lock lights up, the unit can't be switched off or on and all functions are not available until the key lock has been released.

• Key Lock off

To release the key lock by pressing "按鍵鎖(Key Lock)" button again for 3 seconds. The key lock lamp goes out.



11

Air purifying function

During operation, press "負離子(ION)" button to turn on and off the negative ion. When LED is on, the unit releases negative ions to purify the air.



12

The unit will be operated in the range 5~35°C

Important Features

1 Easy to carry with handle and remove with caster.

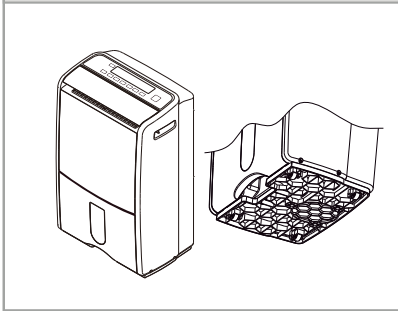

2 Timer setting for auto shut off. (1-12hrs)

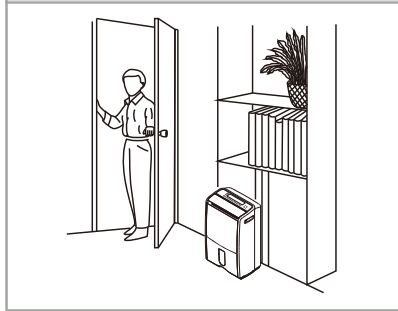

3 LCD display for function and humidity setting.

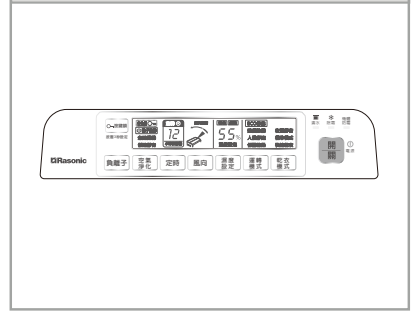

4 Auto louver to change the air outlet direction. 3 louver angle for selection.

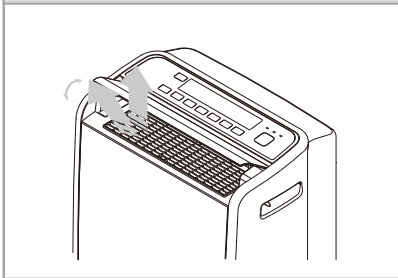

5 ECO mode
Auto humidity setting to keep humidity level between 50-60%.

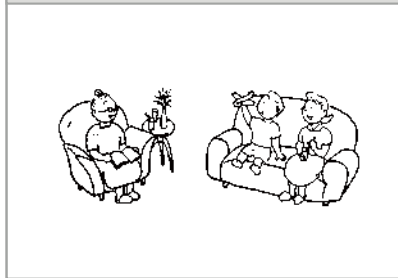

6 Big water tank with 6L volume and 5L shut off.

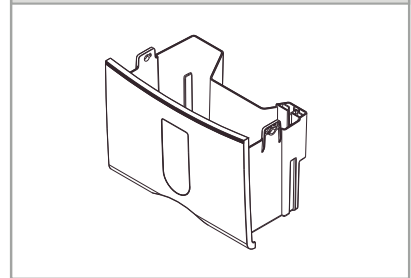

7 Easy to dry cloth or fabric at rainy day.

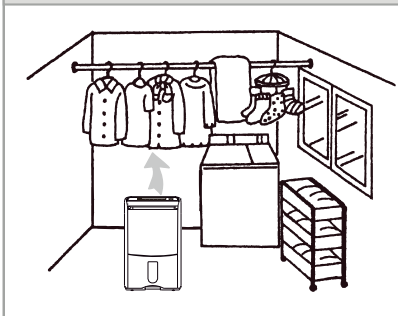

8 Help to dry for wet ceiling and wall.

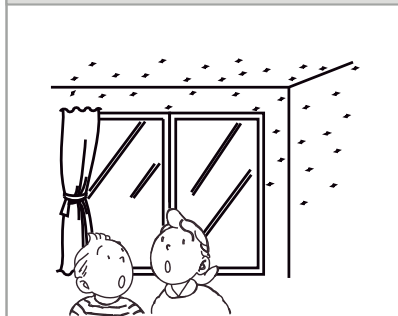

9 Remove moisture of rug or carpet.

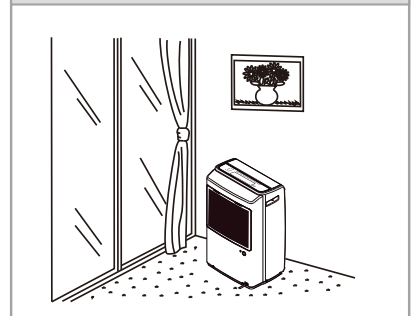

10 Remove moisture inside the cabinet.

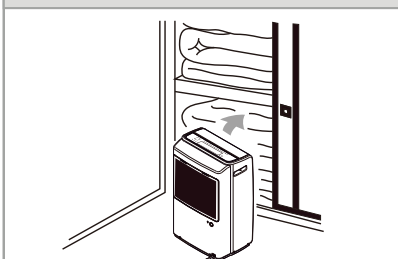

• Please open the door of cabinet to avoid overheating.

11 Protect fabric and leather goods from moldy.

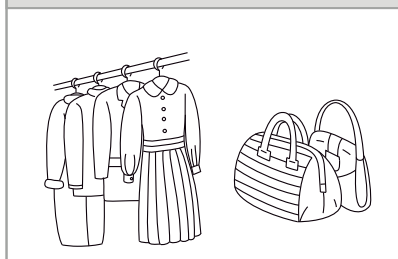

• Please open the door of cabinet to avoid overheating.

12 Suitable for piano or similar music instrument.

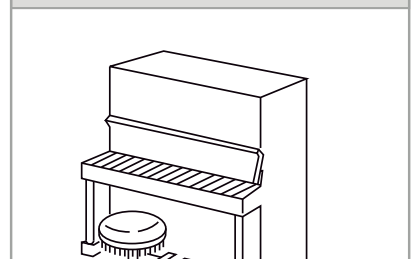

Water Tank Installation

When water tank is full(5L), the water tank full indicator will light up and flash, the unit will stop operation.

Please empty water tank for operation resume.

1 Remove water tank

Insert finger into water container as described and remove water container.

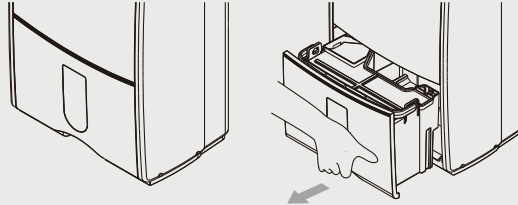

2 Empty water tank

① Please hold the water tank to the appropriate position.

② Empty water and be sure of polyfoam floater in the water tank.

If the float is not attached properly, the unit will not operate correctly and water leak.

③ Replace back tank handle.

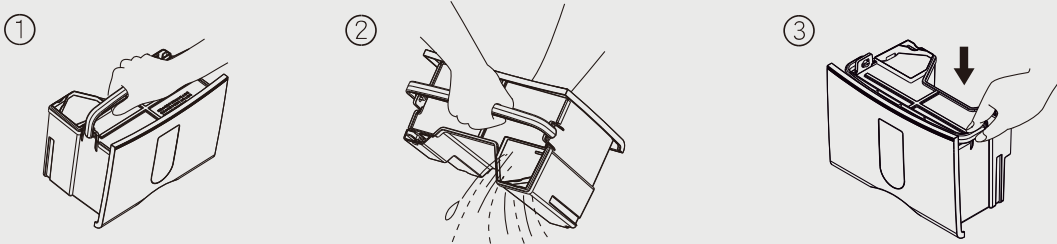

3 Installation

Replace water tank in the unit positionly, the full water LED indicator will light out and the unit remains to work

4 Please do not take out or throw away the polyfoam floater in this water tank, otherwise it will cause auto-stop function failure.

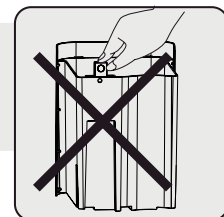

Notice :

- Don't immediately remove water tank when full water LED light up, until few minutes later and no water attached on the cooling system.
- Press power off and empty water before moving the unit to avoid water spillage on floor or penetrate to inner part.
- The dehumidified water on the evaporator is likely to frost at low temperature, which may cause the dehumidification water to not drip inside the water tank, it is not a malfunction.
- Water drain hole at middle plate must be cleaned to avoid water blockage.
- Please do not take out or throw away the polyfoam floater in this water tank, otherwise it will cause auto-stop function failure.

Hose Drain Installation

Continuous Drainage:

Caution: Do not drain water continuously if there is a possibility unattended for long periods.

- 1 Make drain hole by cutting tool.

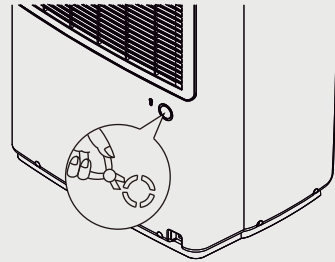

- 2 Insert hose through drain hole.
The inner diameter of the hose is 13-15mm(self purchase item)

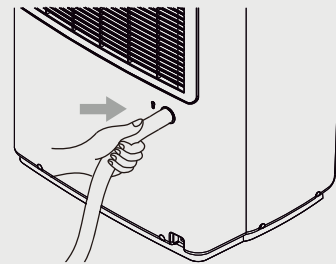

- 3 Connect L shape drain port underneath water drain.

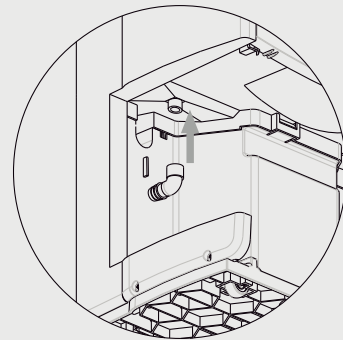

- 4 Reinstall place water tank in proper position.
Dehumidifier does not function if the water tank installed improperly.

Maintenance

★ Disconnect the unit from the power socket before cleaning.

Cleaning of Filter :

Dust or dirt clogged filter will result in reduced dehumidification efficiency and may cause failure. Clean once every 2 weeks.

1 Remove air inlet cover.

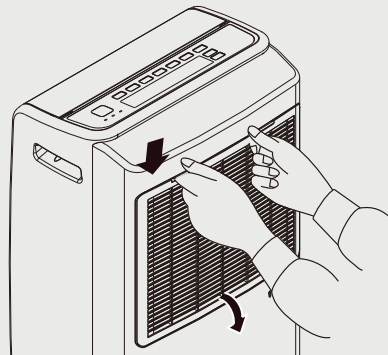

2 Cleaning dust on prefilter under tap water or clean by vacuum cleaner. (Dry the filter before reinstall)



When vacuum cleaner is used, please place dirty face upward.

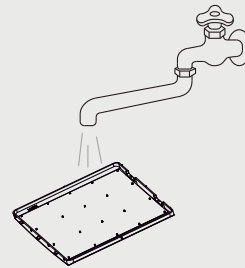

When cleaning pre-filter under tap water, place dirty face downward.

3 Reinstall prefilter in original position. (Be sure of the prefilter is dry)

Notice :

- Please do not use water over 40°C to clean the filter or expose it under the sunlight to avoid deforming the filter.
- In order to avoid the dust flow into the unit which will cause failure, please install the filter to the original position.

Cleaning and Maintenance

Main unit

- 1 Using a soft cloth moistened with warm water (below 40 degree) or mild detergent to wipe the unit.
- 2 Clean with neutral detergent and wipe with a wet cloth.

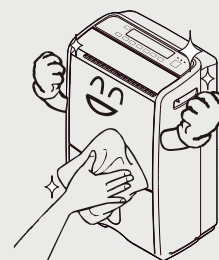

- 3 To avoid short circuit, please clean control panel with dry cloth.

- 4 To avoid surface damage, please do not use solvent, alcohol or thinner as cleaning purpose.



- 5 Do not use volatile chemicals, gasoline, detergents, chemically treated cloths, or other cleaning solutions. All these could possibly hurt the unit.

Storage

1. Completely empty the water tank and wipe it clean and dry.
2. Turning the unit off, unplug and tidy power Cord.
3. Clean the air filter.
4. Cover with plastic bag and place the unit under a area not shone by sun and good ventilation.

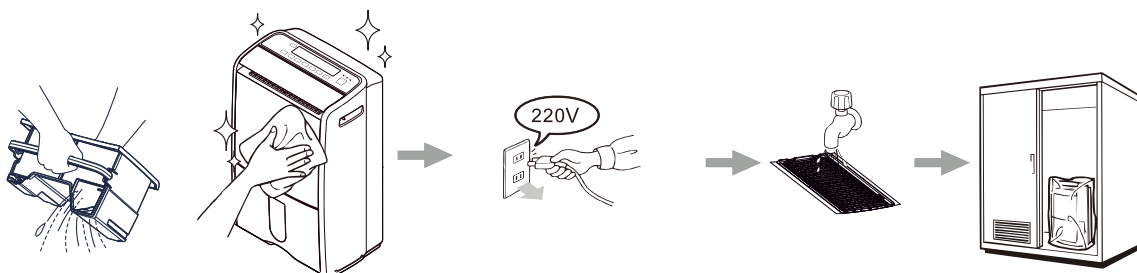

Photocatalytic Filter Cleaning and Replacement

- 1** Remove the photo catalytic filter from the plastic bag.
- 2** Remove air inlet cover , insert the filter into the fixed hook completely.
- 3** When using photo catalytic filter, the amount of dehumidifying is decreased 3-5%
- 4** Before cleaning, stop the unit and turn off the power.
- 5** Photo Catalytic Filter Cleaning (The filter life is about 5 years, please cleaning filter once every 6 months)
Remove the filter, wash it under tap water and place the filter under sunlight to dry for 6 hours.
Don't wash the filter with soap or squeeze the Photo Catalytic Filter to avoid permanent damage.
If the filter becomes damaged, it should be replaced.

HOOK

Photo Catalytic Filter

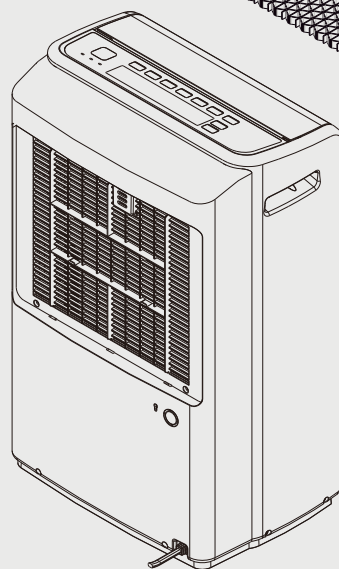
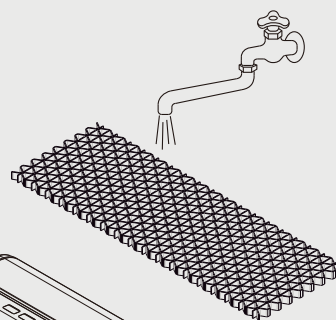
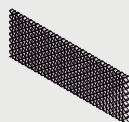
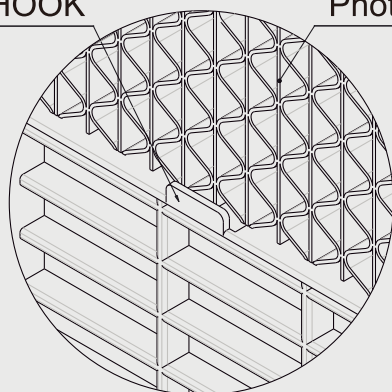

- Filter life differs depending on usage and environmental conditions.
- The Photo Catalytic Filter is consumable, please replace the filter as scheduled. Contact your nearest service centre.

Specifications

Model No.	RPD-YS27GU
Rated Voltage/Frequency	220-240V~ 50Hz
Rated Capacity(L/Day)	14.9L (26.7°C RH60%) 27L (30°C RH80%)
Rated Power	265W
Rated current	1.25A
Refrigerant & Amount	R134a,350g
Tank Capacity	6L (5L Shut off)
Net Weight	15.8 kg
Dimension(mm)	600H x 370W x 263D(mm)

Note

- Dehumidify capacity is subject to the temperature and humidity of the room.
- To avoid dangers, if a power cord damage was found, must be sent back for repairing by Shun Hing Electric Service Centre Co., Ltd.
- This appliance is not intended for used by persons (including children) with reduced physical, sensory or mental capabilities, or lack of experience and knowledge, unless they have been given supervision or instruction concerning use of appliance by a person responsible for their safety.
- Children should be supervised to ensure that they do not play with the appliance.
- Cleaning and user maintenance shall not be made by children without supervision.

Guarantee period starts from the date of purchasing to one year. If the dehumidifier is damaged under proper use, free repair service is available. Please present the official invoice for repair service. For enquiries, please contact Shun Hing Electric Service Centre Limited hotline at 2406 5666.

Special Avowal

1. The information above has been checked. Our company reserves the hermeneutic power to any printing errors or misunderstanding on the content.
2. If there are technical improvements on the appliance, the instruction manual will be updated in new version without prior notice. The product appearance and color are subject to the actual appliance.
3. An electronic copy of the user manual can be emailed to the customer if necessary, please call Shun Hing Electric Works and Engineering Co., Ltd: 28612767

Trouble shooting and Emergency Handling

- Before requesting for repairs, check the following points.

Trouble	Problem cause
① Unit is not operating	<ul style="list-style-type: none"> ① Water tank does not place in the right position ② Water tank is full ③ Power cord is unplugged. ④ Check the fuse switch ⑤ Power failure
② Poor performance	<ul style="list-style-type: none"> ① Air filter obstructed by dirt or dust ② Object obstructing the rear discharge outlet ③ Humidity or temperature may be too low
③ Water leakage	<ul style="list-style-type: none"> ① Drain tube is clogged ② Water tank installed improperly ③ Damaged water tank
④ No humidity remove	<ul style="list-style-type: none"> ① The operated area is too large ② Windows or doors are opened ③ Something producing lots of humidity in the room
⑤ Unit makes a noise	<ul style="list-style-type: none"> ① The Unit is placed improperly ② The floor is not flat
⑥ No wind flow out	<ul style="list-style-type: none"> ① Air filter obstructed by dirt or dust

For Emergency :

- If any abnormalities, please turn off the unit and disconnect the power cord
- If the above solution can not fix the problem, please contact Shun Hing Electric Service Centre Limited for check and repair.



SHUN HING GROUP
信興集團
SINCE 1953

Rasonic 樂信牌

信興電工工程有限公司

SHUN HING ELECTRIC WORKS AND ENGINEERING CO., LTD.

辦公室：香港九龍尖沙咀東部麼地道67號半島中心9樓

電話：(852) 2861 2767

圖文傳真：(852) 2865 6706

網址：<http://www.rasonic.com>

電郵：shew@shunhinggroup.com

Office : 9/F Peninsula Centre, 67 Mody Road, Tsimshatsui East, Kowloon, Hong Kong.

Tel : (852) 2861 2767

Fax : (852) 2865 6706

Web Site : <http://www.rasonic.com>

E-mail : shew@shunhinggroup.com

保養及維修 Maintenance Repair Service:

信興電器服務中心有限公司

SHUN HING ELECTRIC SERVICE CENTRE LTD.

香港新界葵涌勝耀街2號信興中心11樓

電話：(852) 2406 5666

圖文傳真：(852) 2408 0316

消耗品/附件銷售熱線：(852) 2406 5666

網址：www.shesc.com

11th Floor, Shun Hing Centre, 2 Shing Yiu Street, Kwai Chung, New Territories, Hong Kong

Tel : (852) 2406 5666

Fax : (852) 2408 0316

Consumables/Accessories Sales Hotline : (852) 2406 5666

Website : www.shesc.com

客戶服務中心:

香港新界葵涌勝耀街2號信興中心1樓

電話：(852) 2406 5439

傳真：(852) 2408 1389

澳門慕拉士大馬路193-199號南嶺工業大廈5樓1座

電話：(853) 2836 2928

傳真：(853) 2833 6405

有關最新之客務服務中心資訊，請參閱信興服務中心網址：

www.shesc.com 或致電維修服務熱線查詢。

Customer Service Centres:

1 st Floor, Shun Hing Centre, 2 Shing Yiu Street, Kwai Chung, New Territories, Hong Kong

Tel: (852) 2406 5439

Fax: (852) 2408 1389

Avenida de Venceslau de Morais, No. 193-199, 5 andar - I, Edif. Industrial Nam Leng, Macau

Tel: (853) 2836 2928

Fax: (853) 2833 6405

For the latest information of customer service centres,
please visit www.shesc.com or call us at our hotline.

RPD/YS/2210