



SINCE 1909
JAPAN



全新 CARE MODE 貼心程式

自動調節你最舒適的沐浴空間

揭開
仲有更多型號選擇!



總代理 Sole Agent
信興電工工程有限公司
SHUN HING ELECTRIC WORKS AND ENGINEERING CO., LTD.
辦公室 Office 香港九龍沙咀東都喜地庫67號半島中心9樓909-912室
Tsimshatsui East, Kowloon, Hong Kong
電話 Tel (852) 2861 2767
傳真 Fax (852) 2865 6706
網址 Website www.shew.com.hk
電郵 E-mail shew@shunhinggroup.com

保養及維修 Maintenance and Repair Service



信興電器服務中心有限公司
SHUN HING ELECTRIC SERVICE CENTRE LTD.
辦公室 Office 香港新界荃灣顯慶街2號信興中心1樓
1st Floor, Shun Hing Centre, 2 Shing Yiu Street,
Kwai Chung, New Territories, Hong Kong
電話 Tel (852) 2406 5666
傳真 Fax (852) 2408 0316
網址 Website www.shiesc.com



SHUN HING GROUP
信興集團
SINCE 1971

KDK Company, Division of PES
Head Office | 4017, Takaki-cho, Kasugai, Aichi, Japan
Website | <http://kdk.jp>



SINCE 1909
JAPAN

*適用於型號30BWBH/40BECH
*圖片只供參考

CAT-KTV1912
Printed in Hong Kong

此產品已採用環保紙張印刷
Printed with environmental friendly ink on environmental paper
此紙印刷紙張，請盡可能在本港回收紙類。
Due to printing conditions, the actual colour may vary slightly from those shown.
規格如有變更，恕不另行通知。
Specifications are subject to change without prior notice.

源自日本的KDK，一直致力為你提高生活水平，提供一個清新、舒適、優質的生活環境。結合多年來的經驗，KDK不斷創造出優質、可靠的各類型通風產品，除提供為人熟悉的抽氣扇外，還有「浴室寶」浴室換氣暖風機、電風扇、抽濕機、抽油煙機、乾手機、風扇等通風產品。

KDK strives to create a fresh and comfortable living environment that makes people feel good. Accumulating experience from year to year, KDK endeavours to research and develop various types of quality and reliable ventilation products: for instance, thermo ventilators (bathroom dryer and heater), ventilating fans, electric fans, dehumidifiers, range hoods, hand dryers and air curtains.



SINCE 1909
JAPAN



CONTENT

目錄

功能介紹 Features	貼心程式 Care Mode	2
	暖氣功能 Heating	3
	涼乾燥(循環)功能 Dry Cool (Circulation)	4
	熱乾燥(乾衣)功能 Dry Hot (Clothes Drying)	
	換氣功能 Ventilation	
	抗菌過濾網 Alleru-buster Filter	
產品資料 Product Information	窗口式 Window Type	5
	30BWBH	
	30BWAH	7
	23BWAH	9
	天花式 Ceiling Type	
	40BECH	11
	40BEBH	13
	30BGCH	15
型號比較 Model Comparison		17
安裝指引 Installation Guide		18

CARE MODE

貼心 程式

功能介紹

貼心程式 CARE MODE **NEW**

全新內置的貼心程式技術，選定程式後，能自動切換暖氣、熱乾燥及換氣功能，照顧你和家人的各種需要。

The new CARE MODE program can automatically switch to HEATING, DRY HOT and VENTILATION functions according to your needs.



溫暖沐浴 WARM BATH

暖氣預熱浴室至預較的沐浴時間後，自動轉為強檔換氣功能，去除淋浴時產生的悶熱感，隨後轉至弱檔換氣功能，令浴室保持乾爽。

Initiated by HEATING function to preheat the bathroom, when the preset time is up, it is automatically switched to high VENTILATION function to reduce the stifling heat and is followed by low VENTILATION to keep dry in the bathroom.



衣服乾燥 DRY CLOTH

可調較熱乾燥運行的時間進行乾衣，運行結束後自動轉為換氣功能。

Designed to dry clothes by running DRY HOT function with adjustable duration followed by low VENTILATION to keep dry.



空氣清新 REFRESH

以強力換氣運行，短時間為浴室抽出不潔空氣和氣味後，自動轉為低速換氣。

With High VENTILATION function automatically switched to low VENTILATION function, polluted air and odour can be exhausted from bathroom effectively.



24小時換氣 24HR VENTILATION

以低速為浴室不斷進行持續換氣，使浴室保持舒適。

Continued operation of low VENTILATION function allows indoor airflow to keep your bathroom comfortable and healthy.

暖

暖氣功能 Heating

浴室實利用PTC發熱的技術一能在短時間內提升室內溫度，令你及家人在冬天沐浴時享受溫暖舒適的環境，減低着涼的機會，保障家人健康。

Applying PTC (Positive Temperature Coefficient) technology, KDK Thermo Ventilator can warm your bathroom instantly and provides you a comfortable bathing experience.

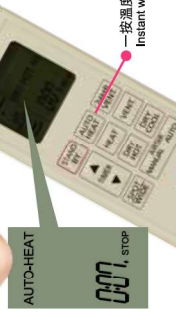

一按溫度提升
Instant warm up

即時提升溫度 環境頓變舒適
Instant warm up to comfortable condition

(只適用於40BEHH)
(40EBH only)

送風模式 / 送風方向
AIR MODE / AIR DIR.

集中 SPOT

自動 AUTO

自動 AUTO

擴散 WIDE

自動 AUTO



達至舒適溫度
Reached to comfortable temperature

涼

涼乾燥(循環)功能 Dry Cool (Circulation)

配合靜音設計，當夏天使用浴室時，浴室實可作風扇使用，即使在狹窄的浴室中亦可感受清涼感覺，保持浴室內空氣流通。

With low noise design, KDK Thermo Ventilator can act as an electric fan and let you feel cool in hot summer.

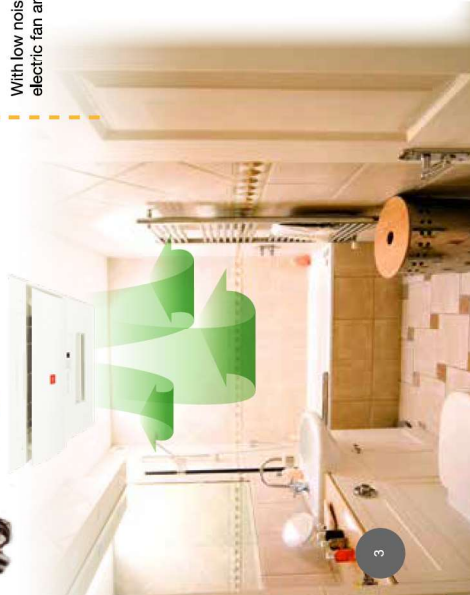

熱乾燥(乾衣)功能 Dry Hot (Clothes Drying)

只需將衣物掛在浴室實下並開啟浴室實，循環氣流便會迅速把衣物弄乾。

Just simply hang your clothes under the Thermo Ventilator and switch it on, circulated airflow will dry your clothes thoroughly.

浴室實運作模式：乾燥功能

Operation mode of PTC type: "Dry-hot" mode

浴室面積：1.6米 x 1.6米 x 2.3米
Area of bathroom: 1.6m x 1.6m x 2.3m
浴室溫度：20°C
Temperature: 20°C
濕潤衣服：3.5公斤
Weight of wet clothes: 3.5kg
浴室濕度：60%
Humidity: 60%

• 40BECH型號之測試結果。乾衣時間視乎衣物質料而有所不同。配合最新送風制度，乾衣效率得以大大提高。The testing result of 40BECH. Clothes drying performance may vary with different clothes materials. With the newly advanced air direction, the clothes drying performance is greatly increased.

乾



89
分鐘 mins

結果 Result
可於89分鐘
把衣物弄乾
It takes only 89
minutes to dry the clothes

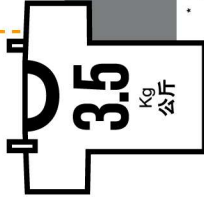

爽

換氣功能 Ventilation

與其他抽氣扇一樣，浴室實能有效地抽出不潔空氣和氣味，除去沐浴時所帶來的濕氣，有效地減少霉菌在浴室內生長的機會。浴室實的設計可配合連續24小時換氣運作，令浴室時刻充滿新鮮空氣，保持潔淨清爽。

KDK Thermo Ventilator can exhaust odor from the bathroom effectively. It can also restrict the growth of mold, mildew & mite by continued operation of 24 hours for this ventilation function.



抗菌過濾網 Alleru-buster Filter

特有SUPER alleru-buster 三合一過濾網，能有效抑制致敏原，病菌及預防細菌霉菌再生，保障健康。

3-in-1 SUPER alleru-buster filter can inhibit allergens, virus and prevent reproduction of bacteria and molds. It can protect your health.

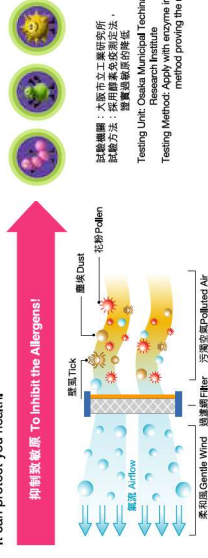

智能
窗口式
window mount

體貼型
DELUXE TYPE
30BWBH

CARE
MODE

全新貼心程式

New CARE MODE

30BWBH的CARE MODE，可根據你的不同需要，自動切換暖氣、熱乾燥及換氣功能，讓你享受更簡易的使用體驗。

30BWBH is empowered with new CARE MODE which allows auto-transition among HEATING, DRY HOT and VENTILATION functions according to your needs.

乾衣功能
Clothes Drying

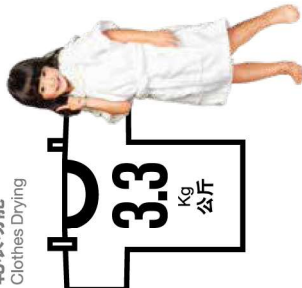

約
155
分鐘 mins

- 面板纖巧輕位
Compact in size
- 高效暖氣及換氣
High efficiency in Heating and Ventilating

浴室面積：1.6米 x 1.6米 x 2.3米
Area of bathroom: 1.6m x 1.6m x 2.3m
濕源衣物：3.3公斤
Weight of wet clothes: 3.3kg

浴室氣溫：20°C
Temperature: 20°C
浴室濕度：60%
Humidity: 60%

控制面板
Switch Panel

所有功能停止*，浴室實進入備用模式
Stop all operations*, turn to stand by status

上下搖擺送風，自動/固定選擇
Vertical Swing Auto/ Fixed Selection

多段預設時間設定 Pre-set timer
最長可預設時間 Max. time

• 暖氣 Heat: 180分鐘 mins
• 換氣 Vent.: 連續運作 CONT.

• 熱乾燥(乾衣) Dry Hot: 360分鐘 mins
• 涼乾燥(循環) Dry Cool: 連續運作 CONT.

* 當按下 STAND BY 停止，兩葉仍會運轉約20秒。
The fan will continue to operate around 20 seconds after turn off all operations.

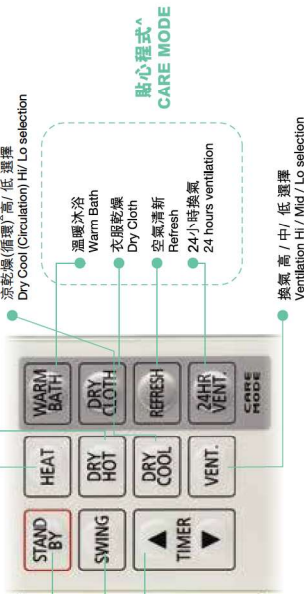

暖氣 高/低選擇
Heating Hi/Lo selection

熱乾燥(乾衣) 高/低選擇
Dry Hot (Clothes Drying) Hi/Lo selection

涼乾燥(循環) 高/低選擇
Dry Cool (Circulation) Hi/Lo selection

溫馨沐浴
Warm Bath

衣類乾燥
Dry Cloth

芳香清新
Refresh

24小時換氣
24 hours ventilation

換氣 高/中/低選擇
Ventilation Hi/Mid/Lo selection

貼心程式^A
CARE MODE

^A 操作詳情請參閱此產品自轉第2頁。
^B 涼乾燥包括循環及換氣。

多角度大範圍送風 The flexibility of Air Direction



上下自動搖擺
Vertical Auto Swing

左右手動調整風向
Horizontal Manual Adjustment

尺寸圖 Dimension 單位: 毫米 mm

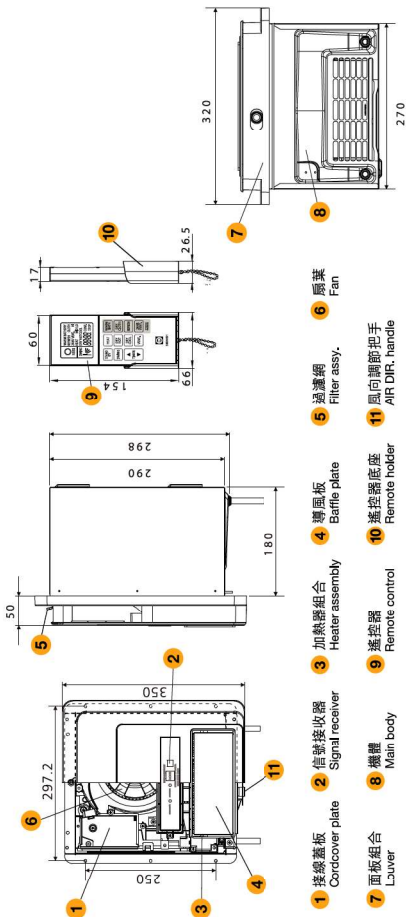

- 1 接蓋板 Cover plate
- 2 信號接收器 Signal receiver
- 3 加熱器組合 Heater assembly
- 4 轉風板 Baffle plate
- 5 過濾網 Filter assy.
- 6 扇葉 Fan
- 7 面板組合 Cover
- 8 機身 Main body
- 9 遙控器 Remote control
- 10 遙控器底座 Remote holder
- 11 風向調節把手 AIR DIR. Handle

規格 Specification

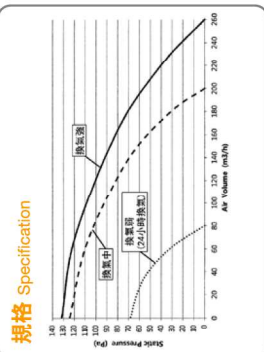

走線圖 Wiring Diagram

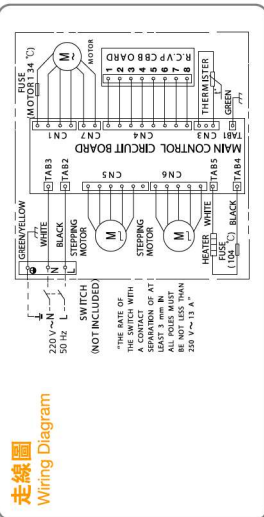

額定電壓 Rated Voltage	額定頻率 Rated Frequency	額定輸入 功率 Rated Power Consumption	建議供電 電源 Recommended Power Source	耗電量 Power Consumption	風量 Air Volume	噪音水平 Noise Level	淨重 Net Weight	安裝尺寸 安裝尺寸 (高 x 闊 x 深) Inst. Size (H x W x D)	扇葉數量 No. of Blade	馬達數量 No. of Motor
220 V	50 Hz	1,440 W	A	1,440 / 38 W	280 m³/h	45 / 45 dB(A)	5.5 kg	350 x 320 x 275 mm (H x W x D) (13% x 10%)	1	1

^A 熱乾燥功能下，扇風板在約45°至35°範圍內上下搖擺。
In Dry hot function, the baffle plate swings up and down within the range of about 45° to 35°.

窗口式
window mount

入門型 BASIC TYPE
30BWAH

簡易安裝之選

Simple installation, more convenience for you
30BWAH的纖細機身設計，可安裝於窗口位置上，可給予你
全能暖氣、乾衣、換氣及循環功能的享受。

30BWAH offers you a full functions experience on heating,
clothes drying, ventilation and circulation while it is slim and
compact in size, fit in window installation.

乾衣功能
Clothes Drying

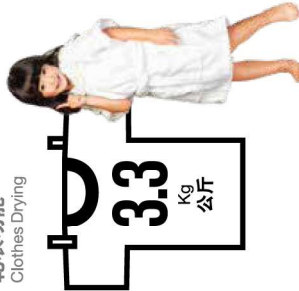

約 161#
分鐘 mins

• 可調校送風
Adjustable Air Direction

浴室面積：1.6米 x 1.6米 x 2.3米
Area of bathroom: 1.6m x 1.6m x 2.3m
濕度：60%
濕源衣物：3.3公斤
Weight of wet clothes: 3.3kg

控制面板
Switch Panel



所有功能停止*，浴室濕氣進入備用模式
Stop all operations*, turn to stand by status

- 多段預設時間設定 Pre-set timer
- 最高可預伏時間 Max. time
- 暖氣 Heat: 180分鐘 mins
- 換氣 Vent: 連續運作 CONT.
- 熱乾燥(乾衣) Dry Hot: 360分鐘 mins
- 涼乾燥(循環) Dry Cool: 連續運作 CONT.

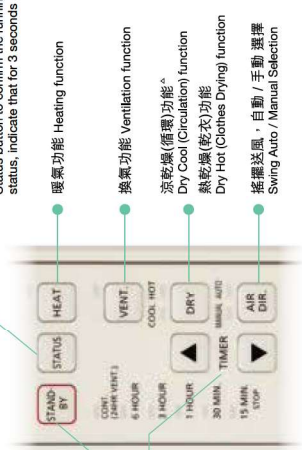

- 暖氣功能 Heating function
- 換氣功能 Ventilation function
- 涼乾燥(循環)功能*
Dry Cool (Circulation) function
- 熱乾燥(乾衣)功能
Dry Hot (Clothes Drying) function
- 搖擺送風、自動 / 手動選擇
Swing Auto / Manual Selection

* 當按下 STAND BY 停止，扇葉仍會運轉約20秒。
The fan will continue to operate around 20 seconds after turn off all operations.

* 涼乾燥包括循環及換氣

多角度大範圍送風 The flexibility of Air Direction



窗口式
更易安裝!



尺寸圖 Dimension 單位: 毫米 mm

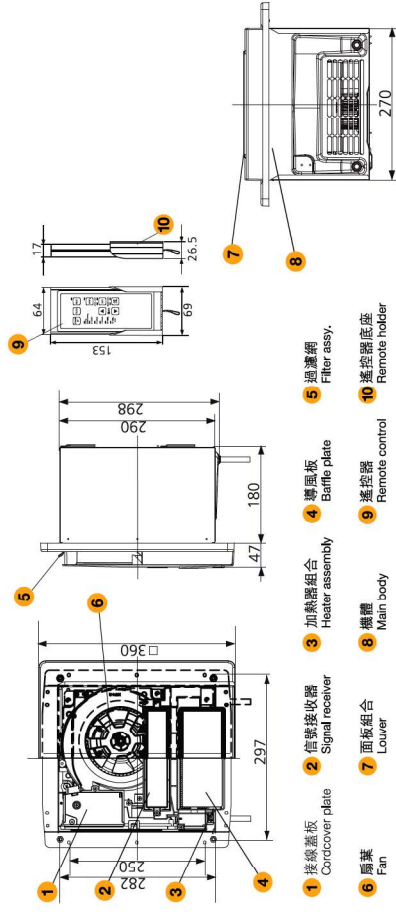

- 1 接線基板 Coverplate
- 2 信號接收器 Signal receiver
- 3 加熱器組合 Heater assembly
- 4 遮風板 Baffle plate
- 5 過濾網 Filter Assy.
- 6 扇葉 Fan
- 7 面板組合 Lower
- 8 機體 Main body
- 9 遙控器 Remote control
- 10 遙控器底座 Remote holder

規格 Specification

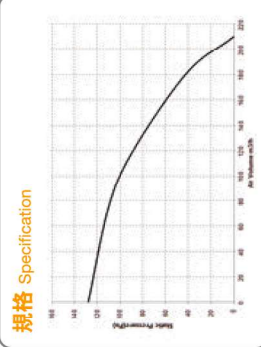

走線圖
Wiring Diagram

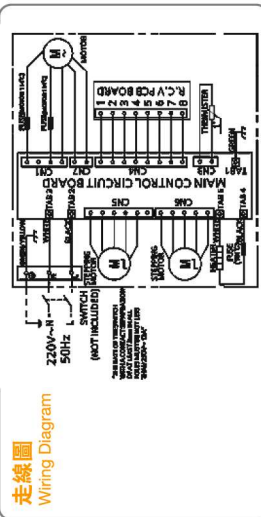

額定電壓 Rated Voltage	額定頻率 Rated Frequency	額定功率 Rated Power	建議供電 電源電流 Recommended Power Source	耗電量 Consumption 最高 Max./ 換氣 Vent.	風量 Air Volume 每小時立方米 CMH	噪音水平 Noise Level 換氣 Vent./ 暖氣 Heat	淨重 Net Weight	安裝尺寸 安裝孔尺寸 Hole Size (高 x 闊 (H x W))	面板尺寸 Lower Size (高 x 闊 (H x W))	扇葉數量 No. of Blade	馬達數量 No. of Motor
220	50	1,330	A	1,330/30	210	40/46	5.1	300 x 275 (11% x 10%)	380 x 360 (14% x 14%)	1	1

窗口式
window mount

纖巧型 SLIM TYPE
23BWAH

細小浴室窗口之選

Simple installation, more convenience for you
23BWAH的纖巧機身設計，可安裝於窗口位置上，可給予你全能暖氣、乾衣、換氣及循環功能的享受。

23BWAH offers you a full functions experience on heating, clothes drying, ventilation and circulation while it is slim and compact in size, fit in window installation.

乾衣功能
Clothes Drying



約 200 分鐘 mins

控制面板
Switch Panel



所有功能停止*，浴室窗進入備用模式
Stop all operations*, turn to stand by status

- 多段預設時間設定 Pre-set timer
- 最長可預設時間 Max. time
- 暖氣 Heat: 180分鐘 mins
- 換氣 Vent: 連續運作 CONT.
- 熱乾燥(乾衣) Dry Hot: 360分鐘 mins
- 涼乾燥(循環) Dry Cool: 連續運作 CONT.

*當按下 STAND BY 停止，扇葉仍會運轉約10秒。
The fan will continue to operate around 10 seconds after turn off all operations.

纖巧型



機身只有280毫米闊
280mm only

- 機身更細，纖巧型擺位之選
Compact in size, free more space
- 抽風力強
Strong in wind pumping
- 特別風口設計，提溫效能高
Special outlet design, high temperature performance



浴室面積: 1.6米 x 1.6米 x 2.3 米
Area of bathroom: 1.6m x 1.6m x 2.3m
浴室溫度: 20°C
Temperature: 20°C
浴室濕度: 60%
Humidity: 60%
濕衣物重: 3.5公斤
Weight of wet clothes: 3.5 Kg

運行出報鐘，按下後有關目前運行狀態的指示燈將會持續顯示3秒
Status button to confirm the running status, indicate that for 3 seconds

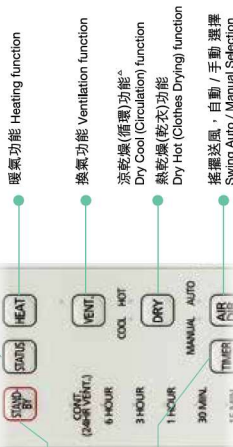

* 涼乾燥包括循環及換氣

多角度大範圍送風 The flexibility of Air Direction



纖巧型
窗口式
更易安裝!

自動搖擺
Auto Swing



特別設計的彈風板，令送風更均勻。

尺寸圖 Dimension 單位: 毫米 mm

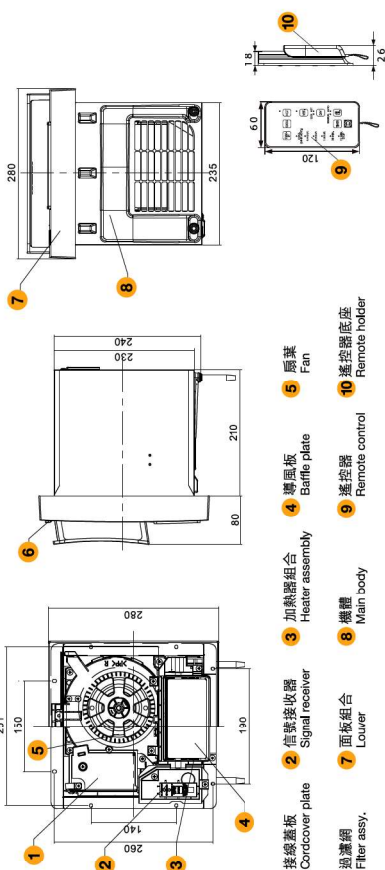

- 1 接線基板 Cordcover plate
- 2 信號接收器 Signal receiver
- 3 加熱器組合 Heater assembly
- 4 遮風板 Baffle plate
- 5 扇葉 Fan
- 6 過濾網 Filter Assy.
- 7 面板組合 Lower
- 8 機體 Main body
- 9 遙控器 Remote control
- 10 遙控器底座 Remote holder

規格 Specification

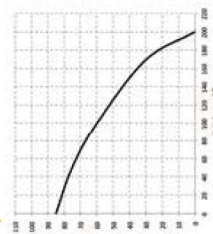

走線圖
Wiring Diagram

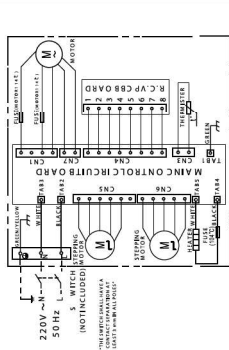

額定電壓 / Rated Voltage	額定頻率 / Rated Frequency	額定功率 / Rated Power	建議供電 / Recommended Power Source	耗電量 / Power Consumption	風量 / Air Volume	噪音水平 / Noise Level	淨重 / Net Weight	安裝孔尺寸 / Installation Hole Size	面板尺寸 / Lower Size	扇葉數量 / No. of Blade	馬達數量 / No. of Motor
220 伏特 V	50 赫茲 Hz	1,160 瓦特 W	A	1,160/28 瓦特 W	200 每小時立方英尺 CFH	46/48 分貝 dBA	4.5 公斤 kg	242 x 238 mm (英寸)	280 x 280 (11 x 11) mm (英寸)	1	1

全新智能
天花板式
ceiling mount

尊尚型 SUPREME TYPE
40BECH

全新貼心程式
New CARE MODE

40BECH的CARE MODE，可根據你的不同需要，自動切換暖氣、熱乾燥及換氣功能，讓你享受更簡易的使用體驗。40BECH is empowered with new CARE MODE which allows auto-transition among HEATING, DRY HOT and VENTILATION functions according to your needs.

乾衣功能
Clothes Drying



3.5
Kg
公斤

約 89 分鐘 mins

- 高效能 PTC，強勁溫暖，快速乾衣
High efficiency PTC, warm up bathroom and dry clothes speedily
- 自動搖擺送風模式
Auto swing mode

浴室面積：1.6米 x 1.6米 x 2.3米
Area of bathroom: 1.6m x 1.6m x 2.3m
濕度效率：3.5分升
Weight or wet clothes: 3.5kg
浴室溫度：20°C
Temperature: 20°C
浴室濕度：80%
Humidity: 80%

控制面板
Switch Panel



所有功能停止，浴室進入靜音模式*
Stop all operations, turn to stand by status*

搖擺送風(自動/固定)選擇
Swing (Auto/Fixed) selection

預設時間設定 Pre-set timer
最長可預設時間 Max. time

• 暖氣 Heat: 180分鐘 mins

• 換氣 Vent.: 連續運作 CONT.

• 熱乾燥(乾衣) Dry Hot: 360分鐘 mins
• 涼乾燥(循環) Dry Cool: 連續運作 CONT.

暖氣強/弱選擇
Heating Hi/Lo selection

集中送風模式/廣散送風模式
Spot Air Mode / Wide Air Mode

熱乾燥(乾衣)/涼乾燥(循環)選擇
Dry Hot (Clothes Drying) / Dry Cool (Circulation) selection

溫暖沐浴
Warm Bath

衣服乾燥
Dry Cloth

空氣清新
Refresh

24小時換氣
24 hours ventilation

換氣強/弱選擇
Ventilation Hi/Lo selection

* 操作詳情請參閱此產品目錄第2頁。
Please refer to page 2 of this catalog for details.

送風方向 / 模式 Air Direction / Modes

集中送風 Spot Air Modes 廣散送風 Wide Air Mode 多角度大范围送風 The flexibility of Air Direction



擋風板
Baffle Plate

自動搖擺
Auto Swing

尺寸圖 Dimension 單位: 毫米 mm

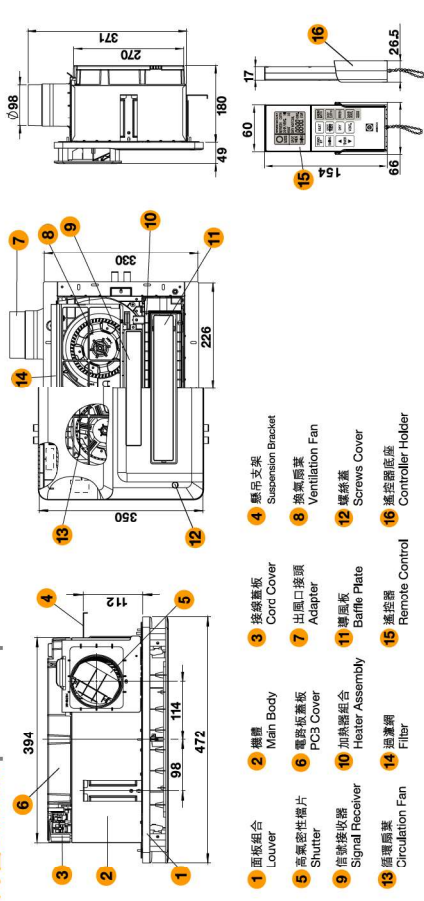

- 1 面板組合 Louver
- 2 機身 Main Body
- 3 接線蓋板 Cord Cover
- 4 懸吊支架 Suspension Bracket
- 5 高氣密性轉片 Shutter
- 6 電源線蓋板 PCB Cover
- 7 出風口接頭 Adapter
- 8 換氣扇葉 Ventilation Fan
- 9 信號接收器 Signal Receiver
- 10 加熱器組合 Heater Assembly
- 11 導風板 Baffle Plate
- 12 螺絲蓋 Screws Cover
- 13 遙控器接收器 Remote Control Receiver
- 14 過濾網 Filter
- 15 遙控器 Remote Control
- 16 遙控器底座 Controller Holder

規格 Specification

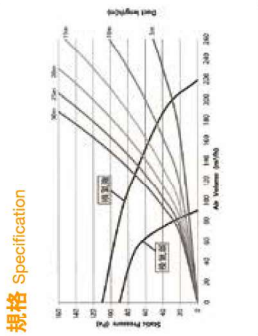

走線圖 Wiring Diagram

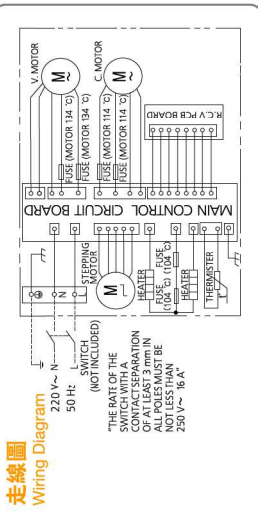

額定電壓 Rated Voltage	額定頻率 Rated Frequency	額定輸入 功率 Rated Power Consumption	建議供電 電壓及 功率 Recommended Power Source	耗電 Power Consumption	風量 Air Volume	噪音水平 Noise Level	淨重 Weight	安裝尺寸 Installation Hole Size	面板尺寸 Lower Size (含 X 風扇 X 風扇)	接管直徑 Duct Diameter	扇葉數量 No. of Blade	馬達數量 No. of Motor
220	50	2,650	A	2,650/29	220	42/45	7.6	280 x 400 (11 x 15 英寸)	350 x 472 (13 英寸 x 18 英寸)	100 (4 英寸)	2	2

產品資料

PRODUCT INFORMATION

天花板 ceiling mount

高級型 DELUXE TYPE 40BEBH

全方位速暖 創造舒適浴室空間
Warm up whole bathroom comfortably

40BEBH擁有的多角度大範圍的自動送風，送出更高效暖風，溫暖浴室每個角落，降低室內不同區域的溫差，防止溫差造成人體體溫失衡，從頭到腳盡享溫暖舒適享受。

40BEBH empowered wide range and flexible air direction, which can warm up whole bathroom evenly. Allowing you to enjoy a warm bathing experience.

乾衣功能
Clothes Drying

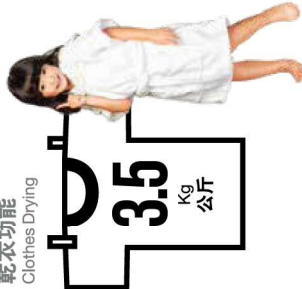

3.5 Kg 公斤

約 92 分鐘 mins

- 高效能 PTC，強勁遠暖，快速乾衣
High efficiency PTC, warm up bathroom and dry clothes speedily
- 自動搖擺送風模式
Auto swing mode

浴室面積：1.6米 x 1.6米 x 2.3米
Area of bathroom: 1.6m X 1.6m X 2.3m
浴室溫度：20°C
Temperature: 20°C
濕氣度：80%
Humidity: 80%
濕氣重量：3.5公斤
Weight of wet clothes: 3.5kg

控制面板
Switch Panel



所有功能停止，浴室進入停用模式*
Stop all operations, turn to stand by status*

- 預設時間調整 Pre-set timer
- 最長可預設時間 Max. time
- 暖氣 Heat: 180分鐘 mins
- 換氣 Vent: 連續運作 CONT., 360分鐘 mins
- 涼乾(循環) Dry Cool: 連續運作 CONT.

集中送風模式 Spot Air Mode
擴散送風模式 Wide Air Mode

- 暖氣自動運作 Auto Heating
- 24小時換氣運作 24 hours ventilation
- 暖氣高/低選擇 Heating function Hi/Lo selection
- 換氣高/低選擇 Ventilation function Hi/Lo selection
- 熱乾燥(乾衣)高/低選擇 Dry Hot (Clothes Drying) function Hi/Lo selection
- 涼乾(循環)高/低選擇 Dry Cool (Circulation) function Hi/Lo selection
- 5段出風風向選擇 5 selections of air direction
- 自動搖擺送風 Auto Swing

* 當按下 STAND BY 停止，風扇仍會運轉約20秒。
The fan will continue to operate around 20 seconds after turn off all operations.

* 涼乾包括循環及換氣

送風方向 / 模式 Air Direction / Modes

集中送風 Spot Air Modes 擴散送風 Wide Air Mode 多角度大範圍送風 The flexibility of Air Direction

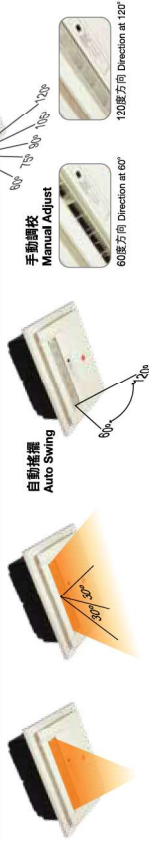

尺寸圖 Dimension 單位: 毫米 mm

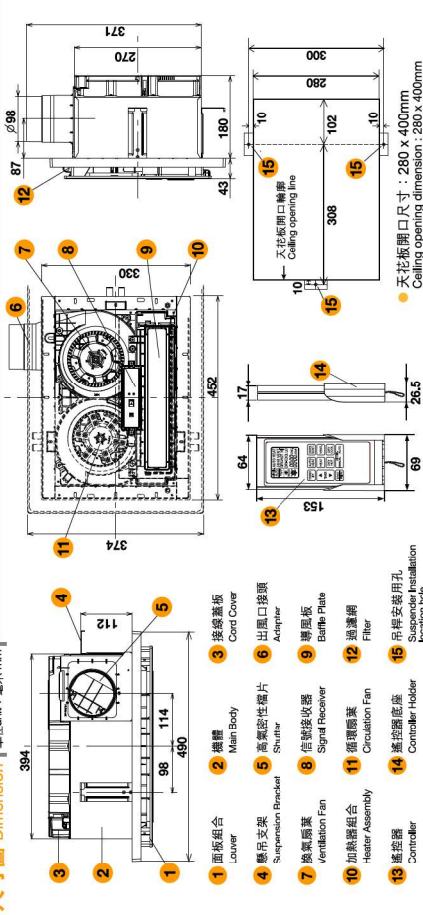

- 1 面板組合 Lower
- 2 機體 Main Body
- 3 送風蓋板 Cold Cover
- 4 懸吊支架 Suspension Bracket
- 5 美觀裝飾墊片 Adapter
- 6 出風口接頭 Shutter
- 7 換氣扇 Ventilation Fan
- 8 信號接收器 Signal Receiver
- 9 導風板 Baffle Plate
- 10 加熱器組合 Heater Assembly
- 11 循環風扇 Circulation Fan
- 12 過濾網 Filter
- 13 遙控器 Controller
- 14 遙控器底座 Controller Holder
- 15 吊桿安裝孔 Location Hole

● 天花板開口尺寸: 280 x 400mm
Ceiling opening dimension: 280 x 400mm

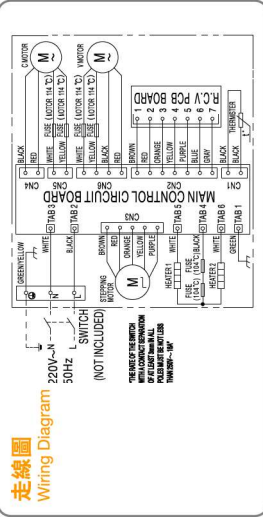
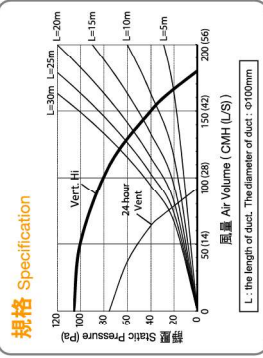

額定電壓 Rated Voltage	220	伏特 V
額定頻率 Rated Frequency	50	赫茲 Hz
額定功率 Rated Power	2,650	瓦特 W
建議供電 電源容量 Recommended Power Source	16	A 瓦特 W
耗電量 Consumption	2,650/23	瓦特 W / 瓦特 W
風量 Air Volume	180	每分鐘立方英尺 CFM
噪音水平 Noise Level	35/45	分貝 dBA
淨重 Weight	7.6	公斤 kg
安裝尺寸 Installation	280 x 400	毫米 (吋) mm (inch)
面網尺寸 Lower Size	490 x 374	毫米 (吋) mm (inch)
轉管直徑 Diameter	100 (4)	毫米 (吋) mm (inch)
扇葉數量 No. of Blade	2	
馬達數量 No. of Motor	2	

天花式 ceiling mount

纖巧型 SLIM TYPE
30BGCH

纖巧型之選

Compact in size, more space for you

30BGCH的纖巧機身設計，可減省安裝位置之餘，更可給予你全能暖氣、乾衣、換氣及循環功能的享受。

30BGCH offers you a full functions experience on heating, clothes drying, ventilation and circulation while it is slim and compact in size.

乾衣功能
Clothes Drying



3.5
Kg
公斤

約 132
分鐘 mins

- 纖巧型機位之選
Compact in size, free more space
- 可傾斜送風
Adjustable Air Direction

浴室面積: 1.6米 x 1.6米 x 2.3米
Area of bathroom: 1.6m X 1.6m X 2.3m
浴室溫度: 20°C
Temperature: 20°C
濕度: 80%
Humidity: 80%
濕度: 60%
Humidity: 60%

控制面板
Switch Panel



所有功能停止*，浴室進入備用模式
Stop all operations*, turn to stand by status

- 多段設定時間設定 Pre-set timer
- 最長可預設時間 Max. time
- 暖氣 Heat: 180分鐘 mins
- 換氣 Vent: 連續運作 CONT.
- 熱乾衣(乾衣) Dry Hot: 360分鐘 mins
- 涼乾衣(循環) Dry Cool: 連續運作 CONT.

*當按下 STAND BY 停止，扇葉仍會轉動約20秒。
The fan will continue to operate around 20 seconds after turn off all operations.

*涼乾機包括循環及換氣

- 暖氣 Heating
- 乾衣 Clothes Drying
- 換氣 Ventilation
- 循環 Circulation
- 無線遙控 Remote Control
- 送風方向 Air Direction
- 抗濕透潮網 Allergen-ester Filter
- 自動擺風 Auto Swing

珍珠白色 Pearl White

多角度大範圍送風 The flexibility of Air Direction



自動擺風 Auto Swing

多角度手動調校 Manual Adjust

擺風片 Blade Plate

120°

60°

尺寸圖 Dimension

單位: 毫米 mm

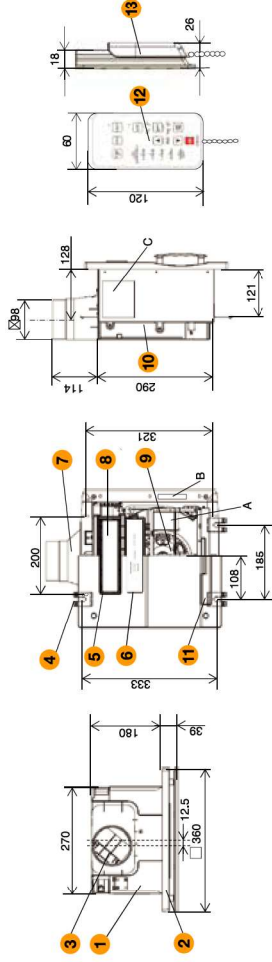

- 1 機體 Main body
- 2 面板組合 Panel assembly
- 3 高氣密性擋片 Shutter
- 4 懸吊支架 Suspension bracket
- 5 加熱器組合 Heater assembly
- 6 信號接收器 Signal Receiver
- 7 出風口接頭 Adapter
- 8 導風板 Baffle plate
- 9 扇葉 Fan
- 10 接線蓋板 Cord cover
- 11 過濾網 Filter assy.
- 12 遙控器 Remote control
- 13 遙控器底座 Controller Holder

規格 Specification

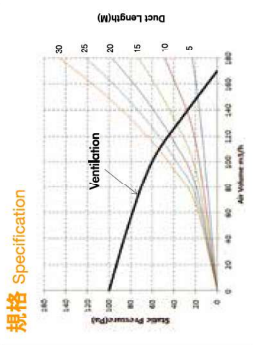

走線圖 Wiring Diagram

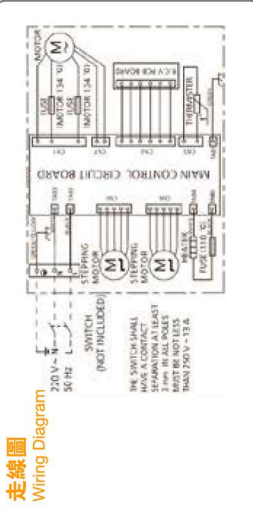

額定電壓 Rated Voltage	220 伏特 V	額定頻率 Rated Frequency	50 赫茲 Hz	額定輸入功率 Rated Power Consumption	1,650 瓦特 W	建議供電容量 Recommended Power Source	A	耗電量 Consumption	1,650 / 28 瓦特 W / 瓦特 W	風量 Air Volume	170 每小時立方英尺 Cfm	噪音水平 Noise Level	39 / 46 換氣 Vent. / 換氣 Vent.	淨重 Net Weight	5.0 公斤 kg	安裝尺寸 Installation	300 x 300 (11% x 11%)	安裝尺寸 Installation	300 x 300 (11% x 11%)	面尺寸 Lower Size	360 x 360 (14% x 14%)	導管直徑 Duct Diameter	100(φ)	扇葉數量 No. of Blade	1	原機數量 No. of Motor	1
-----------------------	----------	-------------------------	----------	-----------------------------------	------------	------------------------------------	---	--------------------	---------------------------	------------------	-----------------------	---------------------	--------------------------------	------------------	--------------	----------------------	--------------------------	----------------------	--------------------------	-------------------	--------------------------	-----------------------	--------	----------------------	---	----------------------	---

型號比較 Model Comparison

	窗口式 Window Mount				天花板式 Ceiling Mount	
	體貼型 Deluxe Type 30BWBH 附注: 深灰色	入門型 Basic Type 30BWAH	纖巧型 Slim Type 23BWAH	新 尊尚型 Supreme Type 40BECH	高級型 Deluxe Type 40BEH	纖巧型 Slim Type 30BGCH
風量 Air Volume (換氣 Vent.-Hi) 每小時立方米 CMH	260	210	200	220	180	170
耗電量 Rated Power Consumption (最高 Max./換氣 Vent.-Hi) 瓦特 W	1440 / 38	1330 / 30	1160 / 28	2650 / 29	2650 / 23	1650 / 28
控制器類型 Remote Type	無線遙控 Wireless Remote	無線遙控 Wireless Remote	無線遙控 Wireless Remote	無線遙控 Wireless Remote	無線遙控 Wireless Remote	無線遙控 Wireless Remote
貼心程式 Care Mode	✓	-	-	✓	-	-
暖氣 Heating	高/低 Hi/L0	✓	✓	高/低 Hi/L0	高/低/自動 Hi/L0/Auto	✓
換氣 Ventilation	高/中/低/24小時 Hi/Mid/L0/24 Hours	✓	✓	高/低/24小時 Hi/L0/24 Hours	高/低 Hi/L0	✓
熱乾燥 (乾衣) Dry Hot (Clothes Drying)	高/低 Hi/L0	✓	✓	✓	高/低 Hi/L0	✓
涼乾燥 (循環) Dry Cool (Circulation)	高/低 Hi/L0	✓	✓	✓	高/低 Hi/L0	✓
時間掣 Timer	✓	✓	✓	✓	✓	✓
送風角度調校 Air Outlet Angle Adjustment	上下自動/固定 Vertical/Auto/Fixed	上下自動/手動 Vertical/Auto/Manual	上下自動/手動 Vertical/Auto/Manual	自動/固定 Auto/Fixed	上下自動/手動 Vertical/Auto/Manual	上下自動/手動 Vertical/Auto/Manual
抗菌過濾網 Allergen-buster Filter	✓	✓	✓	✓	✓	✓

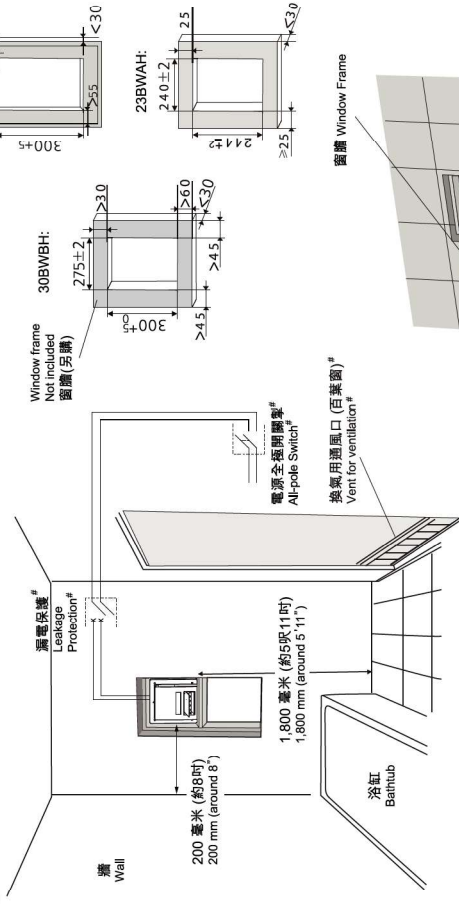

安裝浴室寶機身 Install Main Body

根據牆體及機身尺寸製作半圓牆，並固定安裝在牆紙上。
Make window frame based on the dimensions of window and main body or thermo ventilator, and install on window.
- 窗框 厚度: 30BWBH最少有390(H)X365(W)mm以上/30BWAH最少有390(H)X390(W)mm以上/23BWAH最少有290(H)X290(W)mm以上; Space of window should have 390(H)X365(W)mm or above for 30BWBH, 390(H)X390(W)mm or above for 30BWAH and 290(H)X290(W)mm or above for 23BWAH.
- 牆面厚度最少30mm(紙板合作為牆紙)計算。
Recommend to use thickness less than 30 mm aluminum alloy for the production of window frame.
- 浴室寶機身與牆身距離及其他燃氣材料應最少有200毫米 (約8吋) 距離 200 mm (around 8") space should be kept between the main body of thermo ventilator and the wall/curtains / other flammable materials.
- 安裝浴室寶底部與地面距離保持1,800毫米 (約5呎11吋) 距離; 1,800 mm (around 5'11") space should be kept between the bottom of thermo ventilator and the floor.
- 留意並按照機身上的方向指示標籤，正確安裝產品。
Install main body of thermo ventilator according to the direction indicating label properly.

安裝面罩及掛衣杆 Install Louver and Set Clothes Hanging Pole

將面罩固定主牆上，掛衣杆可安裝在浴室寶出口前方以便進行乾衣。
Install louver with main body of thermo ventilator. Set the clothes hanging pole in front of air outlet grille of thermo ventilator for Dry Hot (clothes drying) function. 100 mm (around 4") space should be kept between the air outlet grille of thermo ventilator and the clothes hanging pole.

安裝控制器 Set Controller

所有型的浴室寶控制器都必須安裝於淋浴區或不容易被水濺濕的地方。安裝時應確保浴室寶機身接收訊號效果。
The controller of all thermo ventilators should be installed away from the bathing / shower area and water-spray area. Before install controller, check the pre-set location for proper signal receiving.

連接電源 Connect Power Source

所有浴室寶應安裝電源全極開關及漏電保護裝置，控制開關及供電。
電源線 請選用已取得認證的IEC 60227 53型或符合UL EEC 60227 01 (BV) 型電源線。30BWBH及30BWAH機身的橫向線路為3 x 1.5平方毫米/23BWAH為 3 x 1.0平方毫米。實際情況符合當地安裝條例。
Please install all-pole power switch and leakage protection for all thermo ventilators to control on/off. Use power cord comply with IEC 60227 53 or IEC 60227 01 (BV), with cross section of 3 x 1.5 mm² for 30BWAH / 3 x 1.0mm² for 23BWAH. Actual installation and wiring should be suggested by authorized contractor.

備註 Remarks
* 有關安裝其他詳情，請參照各型之產品操作說明書。
Other installation details, please refer to Thermo Ventilator Operating and Installation Instruction respectively.

附屬件、線路、電源全極開關、漏電保護、通風口位 (百葉窗)、掛衣杆乃另購件，浴室寶沒有提供，並不包括在浴室寶包裝內。
Window, window frame, all-pole power switch, leakage protection, power cord, vent and clothes hanging pole are sold separately. They are not supplied with and included in the packing of thermo ventilator.

1

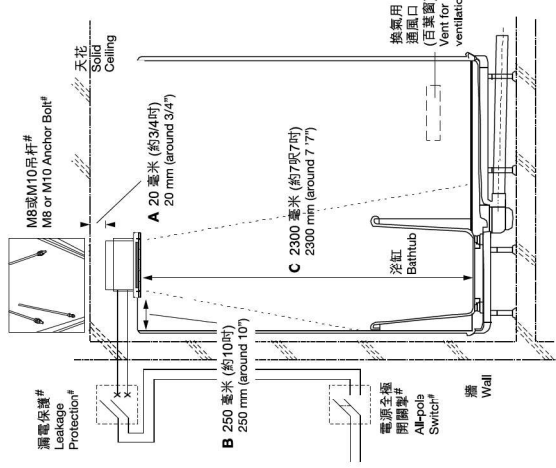

- 吊裝浴室寶 Hang Thermo Ventilator**
- 利用3支M8或M10吊杆[†]，將浴室寶水平地安裝於牢固的天花板上。
Mount the Thermo Ventilator horizontally to the solid ceiling by M8 or M10 anchor bolt[†].
- 浴室寶頂部與天花板最少有20毫米(約3/4吋)距離，以避免機體震動天花板而致不良振動及引起噪音；
The Thermo Ventilator and the ceiling, to avoid vibration and abnormal noise;
 - 浴室寶機身與牆身最少有250毫米(約10吋)距離；
The Thermo Ventilator and the wall;
 - 浴室寶後方至牆出口與地面距離保持2,300毫米(約7呎7吋)距離。
2,300 mm (around 7'7") space should be kept between the air outlet grille and the floor.

連接電源 Connect Power Source

將浴室寶連接電源。
Connect Thermo Ventilator to power source.

- 40BEC/H/40BEH建議使用16安培供電電源；將浴室寶接到獨立16安培或以上類型斷路器 (MCB)；如有需要可安裝20安培雙極斷路器 (俗稱曲線型)。
Recommend use 16A power source for 40BEC/H/40BEH connect Thermo Ventilator to independent 16A or above Miniature Circuit Breaker (MCB), install 20A Cooker Switch if necessary.
- 30GGCH建議使用13安培供電電源；將浴室寶接到內有13安培斷路器的連接盒(俗稱存貯FUSE接線盤)；如有需要可安裝13安培雙極斷路器。
Recommend use 13A power source for 30GGCH connect Thermo Ventilator to 13A Fused Connection Unit, install 13A Two-Pole Switch if necessary.

設置通風口位 Set Vent

要達到有效的換氣效果，請設置通風口位(百葉窗)，有效面積至少於100平方厘米。
For efficient ventilating effect, please set the vent. Effective area should be not less than 100 cm².

2

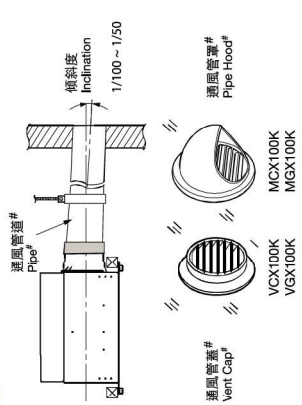

連接通風管 Connect Pipe

使用100毫米(約4吋)直徑通風管連接浴室寶及室外。通風管通風孔直徑為110毫米(約4.3吋)。通風管須向室外向下傾斜1/100-1/50，防止雨水或露水倒流。
Connect Thermo Ventilator and the outside of premise with 100mm (around 4") diameter Pipe[#]. The diameter of Pipe[#] hole is 110 mm (around 4.3"). Connected Pipe[#] should be slanted in 1/100 ~ 1/50 to prevent backward flowing of rain or condensed water.

安裝通風管蓋或罩 Install Vent Cap or Pipe Hood

安裝通風管蓋或罩通風管於室外，以減低露水或長蟲鼠等通風管進入室內的機會。用戶可考慮購買KDK管理附件，型號分別為MCX100K、MGX100K、VCX100K或VGX100K。
Install Vent Cap[#] or Pipe Hood[#] at the outside of premise to reduce chance of intrusion of birds and insects. Please consider to purchase KDK duct work accessories model MCX100K, MGX100K, VCX100K or VGX100K.

3

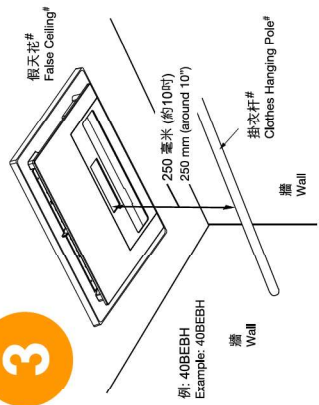

安裝假天花並固定面罩 Set False Ceiling and Louver

安裝假天花及固定面罩。
Set the false ceiling[#] and fix the louver.

安裝掛衣杆 Install Clothes Hanging Pole

掛衣杆[#]可安裝在浴室寶出口風口下方以便進行乾衣。出口風口與掛衣杆[#]應至少保持250毫米(約10吋)距離。
Set the Clothes Hanging Pole[#] for Dry Hot (clothes drying) function, 250 mm (around 10") space should be kept between the air outlet grille of Thermo Ventilator and the Clothes Hanging Pole[#].

4

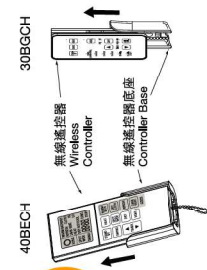

安裝控制器 Set Controller

請安裝所有型號浴室寶遙控器在處於浴室時不可觸及或容易被水濺濕的地方。安裝時請檢測浴室寶機體接收信號效果。
The controller of all Thermo Ventilators should be installed away from the bathing / shower area and water-spray area. Before install controller, check the pre-set location for proper signal receiving.

[†]有關安裝其他詳情，請參照 #M8或M10吊杆、微型斷路器 (MCB)、20安培雙極斷路器 (俗稱曲線型)、內有13安培斷路器的連接盒(俗稱存貯FUSE接線盤)、13安培雙極斷路器、電源全極斷路器、通風管蓋、通風管罩、通風管蓋、假天花、掛衣杆、牆內接線盒、電源線槽、乃5分膠件，浴室寶沒有提供，並不包括在浴室寶包裝內。 13A Fused Connection Unit, 13A Two-Pole Switch, All-pole Power Switch, Leakage Protection, Power Cord, Pipe Hood, Duct Cap, False Ceiling, Clothes Hanging Pole, Junction Box and Cable Tray are sold separately. They are not supplied with and included in the packing of Thermo Ventilator.

備註 Remarks
Other installation details, please refer to the installation manual.
13A Fused Connection Unit, 13A Two-Pole Switch, All-pole Power Switch, Leakage Protection, Power Cord, Pipe Hood, Duct Cap, False Ceiling, Clothes Hanging Pole, Junction Box and Cable Tray are sold separately. They are not supplied with and included in the packing of Thermo Ventilator.

